

# DUAL 16-/14-/12-BIT, ULTRALOW-GLITCH, LOW-POWER, BUFFERED, VOLTAGE-OUTPUT DAC WITH 2.5-V, 4-PPM/°C INTERNAL REFERENCE IN SMALL 3-MM × 3-MM QFN

 Check for Samples: [DAC8562](#), [DAC8563](#), [DAC8162](#), [DAC8163](#), [DAC7562](#), [DAC7563](#)

## FEATURES

- **Relative Accuracy:**
  - **DAC856x (16-Bit): 4 LSB INL**
  - **DAC816x (14-Bit): 1 LSB INL**
  - **DAC756x (12-Bit): 0.3 LSB INL**
- **Glitch Energy: 0.1 nV-s**
- **Bidirectional Reference: Input or 2.5-V Output**
  - **Output Disabled by Default**
  - **±5-mV Initial Accuracy (Max)**
  - **4-ppm/°C Temperature Drift (Typ)**
  - **10-ppm/°C Temperature Drift (Max)**
  - **20-mA Sink/Source Capability**
- **Power-On Reset to Zero Scale or Mid-Scale**
- **Low-Power: 4 mW (Typ, 5-V AV<sub>DD</sub>, Including Internal Reference Current)**
- **Wide Power-Supply Range: 2.7 V to 5.5 V**
- **50-MHz SPI With Schmitt-Triggered Inputs**
- **LDAC and CLR Functions**
- **Output Buffer With Rail-to-Rail Operation**
- **Packages: QFN-10 (3x3 mm), MSOP-10**
- **Temperature Range: –40°C to 125°C**

## APPLICATIONS

- **Portable Instrumentation**
- **Bipolar Outputs ([reference design](#))**
- **PLC Analog Output Module ([reference design](#))**
- **Closed-Loop Servo Control**
- **Voltage Controlled Oscillator Tuning**
- **Data Acquisition Systems**
- **Programmable Gain and Offset Adjustment**

## DESCRIPTION

The DAC856x, DAC816x, and DAC756x are low-power, voltage-output, dual-channel, 16-, 14-, and 12-bit digital-to-analog converters (DACs), respectively. These devices include a 2.5-V, 4-ppm/°C internal reference, giving a full-scale output voltage range of 2.5 V or 5 V. The internal reference has an initial accuracy of ±5 mV and can source or sink up to 20 mA at the V<sub>REFIN</sub>/V<sub>REFOUT</sub> pin.

These devices are monotonic, providing excellent linearity and minimizing undesired code-to-code transient voltages (glitch). They use a versatile three-wire serial interface that operates at clock rates up to 50 MHz. The interface is compatible with standard SPI™, QSPI™, Microwire™, and digital signal processor (DSP) interfaces. The DACxx62 devices incorporate a power-on-reset circuit that ensures the DAC output powers up at zero scale until a valid code is written to the device, whereas the DACxx63s similarly power up at mid-scale. These devices contain a power-down feature that reduces current consumption to typically 10 nA at 5 V. The low power consumption, internal reference, and small footprint make these devices ideal for portable, battery-operated equipment.

The DACxx62 devices are drop-in and function-compatible with each other, as are the DACxx63s. The entire family is available in MSOP-10 and QFN-10 packages.

**Table 1. RELATED DEVICES**

|                           | 16-BIT                  | 14-BIT                  | 12-BIT                  |
|---------------------------|-------------------------|-------------------------|-------------------------|
| <b>Reset to zero</b>      | <a href="#">DAC8562</a> | <a href="#">DAC8162</a> | <a href="#">DAC7562</a> |
| <b>Reset to mid-scale</b> | <a href="#">DAC8563</a> | <a href="#">DAC8163</a> | <a href="#">DAC7563</a> |

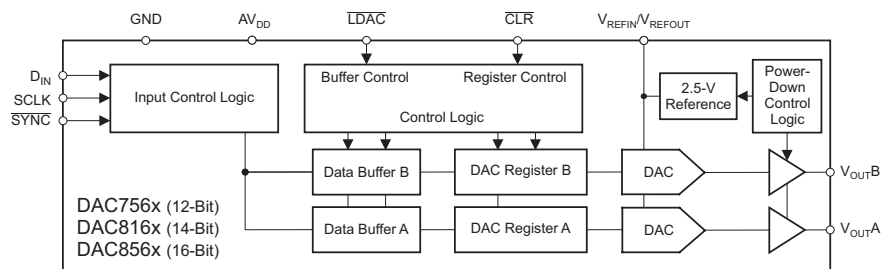

Please be aware that an important notice concerning availability, standard warranty, and use in critical applications of Texas Instruments semiconductor products and disclaimers thereto appears at the end of this data sheet.

SPI, QSPI are trademarks of Motorola, Inc.  
Microwire is a trademark of National Semiconductor.



This integrated circuit can be damaged by ESD. Texas Instruments recommends that all integrated circuits be handled with appropriate precautions. Failure to observe proper handling and installation procedures can cause damage.

ESD damage can range from subtle performance degradation to complete device failure. Precision integrated circuits may be more susceptible to damage because very small parametric changes could cause the device not to meet its published specifications.

**DEVICE INFORMATION<sup>(1)</sup>**

| PRODUCT | MAXIMUM RELATIVE ACCURACY (LSB) | MAXIMUM DIFFERENTIAL NONLINEARITY (LSB) | MAXIMUM REFERENCE DRIFT (ppm/°C) | RESET TO  | PACKAGE-LEAD | PACKAGE DESIGNATOR | SPECIFIED TEMPERATURE RANGE | PACKAGE MARKING |      |
|---------|---------------------------------|---|----------------------------------|-----------|--------------|--------------------|-----------------------------|-----------------|------|
| DAC8562 | ±12                             | ±1                                      | 10                               | Zero      | QFN-10       | DSC                | –40°C to 125°C              | 8562            |      |
| DAC8563 |                                 |   |                                  | Mid-scale | MSOP-10      | DGS                |                             | 8563            |      |
| DAC8162 | ±3                              | ±0.5                                    | 10                               | Zero      | QFN-10       | DSC                |                             | –40°C to 125°C  | 8162 |
| DAC8163 |                                 |   |                                  | Mid-scale | MSOP-10      | DGS                |                             |                 | 8163 |
| DAC7562 | ±0.75                           | ±0.25                                   | 10                               | Zero      | QFN-10       | DSC                | –40°C to 125°C              |                 | 7562 |
| DAC7563 |                                 |   |                                  | Mid-scale | MSOP-10      | DGS                |                             |                 | 7563 |

(1) For the most current package and ordering information, see the Package Option Addendum at the end of this data sheet, or see the TI Web site at [www.ti.com](http://www.ti.com).

## ABSOLUTE MAXIMUM RATINGS<sup>(1)</sup>

Over operating free-air temperature range (unless otherwise noted).

|  | VALUE                  | UNIT |
|--|------------------------|------|
| $V_{DD}$ to GND  | -0.3 to 6              | V    |
| $\overline{CLR}$ , $D_{IN}$ , $\overline{LDAC}$ , $\overline{SCLK}$ and $\overline{SYNC}$ input voltage to GND | -0.3 to $V_{DD} + 0.3$ | V    |
| $V_{OUT}$ to GND   | -0.3 to $V_{DD} + 0.3$ | V    |
| $V_{REFIN}/V_{REFOUT}$ to GND  | -0.3 to $V_{DD} + 0.3$ | V    |
| Operating temperature range  | -40 to 125             | °C   |
| Junction temperature, maximum ( $T_{Jmax}$ )   | 150                    | °C   |

- (1) Stresses beyond those listed under *Absolute Maximum Ratings* may cause permanent damage to the device. These are stress ratings only, and functional operation of the device at these or any other conditions beyond those indicated under *Recommended Operating Conditions* is not implied. Exposure to absolute-maximum-rated conditions for extended periods may affect device reliability.

## THERMAL INFORMATION

| THERMAL METRIC    |   | DAC856x, DAC816x, DAC756x |         | UNIT |
|-------------------|---|---------------------------|---------|------|
|                   |   | DSC                       | DGS     |      |
|                   |   | 10 PINS                   | 10 PINS |      |
| $\theta_{JA}$     | Junction-to-ambient thermal resistance <sup>(1)</sup>       | 62.8                      | 173.8   | °C/W |
| $\theta_{JCTop}$  | Junction-to-case (top) thermal resistance <sup>(2)</sup>    | 44.3                      | 48.5    | °C/W |
| $\theta_{JB}$     | Junction-to-board thermal resistance <sup>(3)</sup>         | 26.5                      | 79.9    | °C/W |
| $\Psi_{JT}$       | Junction-to-top characterization parameter <sup>(4)</sup>   | 0.4                       | 1.7     | °C/W |
| $\Psi_{JB}$       | Junction-to-board characterization parameter <sup>(5)</sup> | 25.5                      | 68.4    | °C/W |
| $\theta_{JCbott}$ | Junction-to-case (bottom) thermal resistance <sup>(6)</sup> | 46.2                      | N/A     | °C/W |

- (1) The junction-to-ambient thermal resistance under natural convection is obtained in a simulation on a JEDEC-standard, high-K board, as specified in JESD51-7, in an environment described in JESD51-2a.
- (2) The junction-to-case (top) thermal resistance is obtained by simulating a cold plate test on the package top. No specific JEDEC-standard test exists, but a close description can be found in the ANSI SEMI standard G30-88.
- (3) The junction-to-board thermal resistance is obtained by simulating in an environment with a ring cold plate fixture to control the PCB temperature, as described in JESD51-8.
- (4) The junction-to-top characterization parameter,  $\Psi_{JT}$ , estimates the junction temperature of a device in a real system and is extracted from the simulation data for obtaining  $\theta_{JA}$ , using a procedure described in JESD51-2a (sections 6 and 7).
- (5) The junction-to-board characterization parameter,  $\Psi_{JB}$ , estimates the junction temperature of a device in a real system and is extracted from the simulation data for obtaining  $\theta_{JA}$ , using a procedure described in JESD51-2a (sections 6 and 7).
- (6) The junction-to-case (bottom) thermal resistance is obtained by simulating a cold plate test on the exposed (power) pad. No specific JEDEC standard test exists, but a close description can be found in the ANSI SEMI standard G30-88.

## ELECTRICAL CHARACTERISTICS

At  $V_{DD} = 2.7\text{ V to }5.5\text{ V}$  and  $T_A = -40^\circ\text{C to }125^\circ\text{C}$  (unless otherwise noted).

| PARAMETER                                   |   | TEST CONDITIONS                                 | MIN                  | TYP   | MAX       | UNIT             |
|---|---|---|----------------------|-------|-----------|------------------|
| <b>STATIC PERFORMANCE<sup>(1)</sup></b>     |   |   |                      |       |           |                  |
| DAC856x                                     | Resolution  |   | 16                   |       |           | Bits             |
|   | Relative accuracy   | Using line passing through codes 512 and 65,024 |                      | ±4    | ±12       | LSB              |
|   | Differential nonlinearity   | 16-bit monotonic                                |                      | ±0.2  | ±1        | LSB              |
| DAC816x                                     | Resolution  |   | 14                   |       |           | Bits             |
|   | Relative accuracy   | Using line passing through codes 128 and 16,256 |                      | ±1    | ±3        | LSB              |
|   | Differential nonlinearity   | 14-bit monotonic                                |                      | ±0.1  | ±0.5      | LSB              |
| DAC756x                                     | Resolution  |   | 12                   |       |           | Bits             |
|   | Relative accuracy   | Using line passing through codes 32 and 4,064   |                      | ±0.3  | ±0.75     | LSB              |
|   | Differential nonlinearity   | 12-bit monotonic                                |                      | ±0.05 | ±0.25     | LSB              |
| Offset error                                | Extrapolated from two-point line <sup>(1)</sup> , unloaded                  |   |                      | ±1    | ±4        | mV               |
| Offset error drift                          |   |   |                      | ±2    |           | μV/°C            |
| Full-scale error                            | DAC register loaded with all 1s   |   |                      | ±0.03 | ±0.2      | % FSR            |
| Zero-code error                             | DAC register loaded with all 0s   |   |                      | 1     | 4         | mV               |
| Zero-code error drift                       |   |   |                      | ±2    |           | μV/°C            |
| Gain error                                  | Extrapolated from two-point line <sup>(1)</sup> , unloaded                  |   |                      | ±0.01 | ±0.15     | % FSR            |
| Gain temperature coefficient                |   |   |                      | ±1    |           | ppm FSR/°C       |
| <b>OUTPUT CHARACTERISTICS<sup>(2)</sup></b> |   |   |                      |       |           |                  |
| Output voltage range                        |   |   | 0                    |       | $AV_{DD}$ | V                |
| Output voltage settling time <sup>(3)</sup> | DACs unloaded   |   |                      | 7     |           | μs               |
|   | $R_L = 1\text{ M}\Omega$  |   |                      | 10    |           |                  |
| Slew rate                                   | Measured between 20% - 80% of a full-scale transition                       |   |                      | 0.75  |           | V/μs             |
| Capacitive load stability                   | $R_L = \infty$  |   |                      | 1     |           | nF               |
|   | $R_L = 2\text{ k}\Omega$  |   |                      | 3     |           |                  |
| Code-change glitch impulse                  | 1-LSB change around major carry   |   |                      | 0.1   |           | nV-s             |
| Digital feedthrough                         | SCLK toggling, $\overline{\text{SYNC}}$ high                                |   |                      | 0.1   |           | nV-s             |
| Power-on glitch impulse                     | $R_L = 2\text{ k}\Omega$ , $C_L = 470\text{ pF}$ , $AV_{DD} = 5.5\text{ V}$ |   |                      | 40    |           | mV               |
| Channel-to-channel dc crosstalk             | Full-scale swing on adjacent channel, External reference                    |   |                      | 5     |           | μV               |
|   | Full-scale swing on adjacent channel, Internal reference                    |   |                      | 15    |           |                  |
| DC output impedance                         | At mid-scale input  |   |                      | 5     |           | Ω                |
| Short-circuit current                       | DAC outputs at full-scale, DAC outputs shorted to GND                       |   |                      | 40    |           | mA               |
| Power-up time, including settling time      | Coming out of power-down mode   |   |                      | 50    |           | μs               |
| <b>AC PERFORMANCE<sup>(2)</sup></b>         |   |   |                      |       |           |                  |
| DAC output noise density                    | $T_A = 25^\circ\text{C}$ , at mid-scale input, $f_{OUT} = 1\text{ kHz}$     |   |                      | 90    |           | nV/√Hz           |
| DAC output noise                            | $T_A = 25^\circ\text{C}$ , at mid-scale input, 0.1 Hz to 10 Hz              |   |                      | 2.6   |           | μV <sub>PP</sub> |
| <b>LOGIC INPUTS<sup>(2)</sup></b>           |   |   |                      |       |           |                  |
| Input pin Leakage current                   |   |   | -1                   | ±0.1  | 1         | μA               |
| Logic input LOW voltage $V_{INL}$           |   |   | 0                    |       | 0.8       | V                |
| Logic input HIGH voltage $V_{INH}$          |   |   | $0.7 \times AV_{DD}$ |       | $AV_{DD}$ | V                |
| Pin capacitance                             |   |   |                      |       | 3         | pF               |

(1) 16-bit: codes 512 and 65,024; 14-bit: codes 128 and 16,256; 12-bit: codes 32 and 4,064

(2) Specified by design or characterization

(3) Transition time between 1/4 scale and 3/4 scale including settling to within ±0.024% FSR

**ELECTRICAL CHARACTERISTICS (continued)**

At  $AV_{DD} = 2.7\text{ V to }5.5\text{ V}$  and  $T_A = -40^\circ\text{C to }125^\circ\text{C}$  (unless otherwise noted).

| PARAMETER   |  | TEST CONDITIONS   | MIN   | TYP       | MAX       | UNIT                    |
|---|--|---|-------|-----------|-----------|-------------------------|
| <b>REFERENCE</b>                                    |  |   |       |           |           |                         |
| External reference current                          |  | External $V_{REF} = 2.5\text{ V}$ (when internal reference is disabled), all channels active using gain = 1 |       | 15        |           | $\mu\text{A}$           |
| $V_{REFIN}$ reference input range                   |  |   | 0     |           | $AV_{DD}$ | V                       |
| Reference input impedance                           |  | Internal reference disabled, gain = 1   |       | 170       |           | k $\Omega$              |
|   |  | Internal reference disabled, gain = 2   |       | 85        |           |                         |
| <b>REFERENCE OUTPUT</b>                             |  |   |       |           |           |                         |
| Output voltage                                      |  | $T_A = 25^\circ\text{C}$  | 2.495 | 2.5       | 2.505     | V                       |
| Initial accuracy                                    |  | $T_A = 25^\circ\text{C}$  | -5    | $\pm 0.1$ | 5         | mV                      |
| Output voltage temperature drift <sup>(4)</sup>     |  |   |       | 4         | 10        | ppm/ $^\circ\text{C}$   |
| Output voltage noise                                |  | $f = 0.1\text{ Hz to }10\text{ Hz}$   |       | 12        |           | $\mu\text{V}_{PP}$      |
| Output voltage noise density (high-frequency noise) |  | $T_A = 25^\circ\text{C}$ , $f = 1\text{ kHz}$ , $C_L = 0\text{ }\mu\text{F}$                                |       | 250       |           | nV/ $\sqrt{\text{Hz}}$  |
|   |  | $T_A = 25^\circ\text{C}$ , $f = 1\text{ MHz}$ , $C_L = 0\text{ }\mu\text{F}$                                |       | 30        |           |                         |
|   |  | $T_A = 25^\circ\text{C}$ , $f = 1\text{ MHz}$ , $C_L = 4.7\text{ }\mu\text{F}$                              |       | 10        |           |                         |
| Load regulation, sourcing <sup>(5)</sup>            |  | $T_A = 25^\circ\text{C}$  |       | 20        |           | $\mu\text{V}/\text{mA}$ |
| Load regulation, sinking <sup>(5)</sup>             |  | $T_A = 25^\circ\text{C}$  |       | 185       |           | $\mu\text{V}/\text{mA}$ |
| Output current load capability <sup>(6)</sup>       |  |   |       | $\pm 20$  |           | mA                      |
| Line regulation                                     |  | $T_A = 25^\circ\text{C}$  |       | 50        |           | $\mu\text{V}/\text{V}$  |
| Long-term stability/drift (aging) <sup>(5)</sup>    |  | $T_A = 25^\circ\text{C}$ , time = 0 to 1900 hours   |       | 100       |           | ppm                     |
| Thermal hysteresis <sup>(5)</sup>                   |  | First cycle   |       | 200       |           | ppm                     |
|   |  | Additional cycles   |       | 50        |           |                         |
| <b>POWER REQUIREMENTS<sup>(7)</sup></b>             |  |   |       |           |           |                         |
| Power supply voltage                                |  |   | 2.7   |           | 5.5       | V                       |
| $I_{DD}$  | $AV_{DD} = 3.6\text{ V to }5.5\text{ V}$ | Normal mode, internal reference off   |       | 0.25      | 0.5       | mA                      |
|   |  | Normal mode, internal reference on  |       | 0.8       | 1.3       |                         |
|   |  | Power-down modes <sup>(8)</sup>   |       | 0.01      | 1         | $\mu\text{A}$           |
|   |  | Power-down modes <sup>(9)</sup>   |       | 0.01      | 3         |                         |
|   | $AV_{DD} = 2.7\text{ V to }3.6\text{ V}$ | Normal mode, internal reference off   |       | 0.2       | 0.4       | mA                      |
|   |  | Normal mode, internal reference on  |       | 0.73      | 1.3       |                         |
|   |  | Power-down modes <sup>(8)</sup>   |       | 0.008     | 1         | $\mu\text{A}$           |
|   |  | Power-down modes <sup>(9)</sup>   |       | 0.008     | 3         |                         |
| Power dissipation                                   | $AV_{DD} = 3.6\text{ V to }5.5\text{ V}$ | Normal mode, internal reference off   |       | 0.9       | 2.75      | mW                      |
|   |  | Normal mode, internal reference on  |       | 2.9       | 7.15      |                         |
|   |  | Power-down modes <sup>(8)</sup>   |       | 0.04      | 5.5       | $\mu\text{W}$           |
|   |  | Power-down modes <sup>(9)</sup>   |       | 0.04      | 16.5      |                         |
|   | $AV_{DD} = 2.7\text{ V to }3.6\text{ V}$ | Normal mode, internal reference off   |       | 0.54      | 1.44      | mW                      |
|   |  | Normal mode, internal reference on  |       | 1.97      | 4.68      |                         |
|   |  | Power-down modes <sup>(8)</sup>   |       | 0.02      | 3.6       | $\mu\text{W}$           |
|   |  | Power-down modes <sup>(9)</sup>   |       | 0.02      | 10.8      |                         |
| <b>TEMPERATURE RANGE</b>                            |  |   |       |           |           |                         |
| Specified performance                               |  |   | -40   |           | 125       | $^\circ\text{C}$        |

(4) Internal reference output voltage temperature drift is characterized from  $-40^\circ\text{C to }125^\circ\text{C}$ .

(5) Explained in more detail in the *Application Information* section of this data sheet.

(6) Specified by design or characterization

(7) Input code = mid-scale, no load,  $V_{INH} = AV_{DD}$ , and  $V_{INL} = \text{GND}$ 

(8) Temperature range  $-40^\circ\text{C to }105^\circ\text{C}$ 

(9) Temperature range  $-40^\circ\text{C to }125^\circ\text{C}$

## PIN CONFIGURATIONS

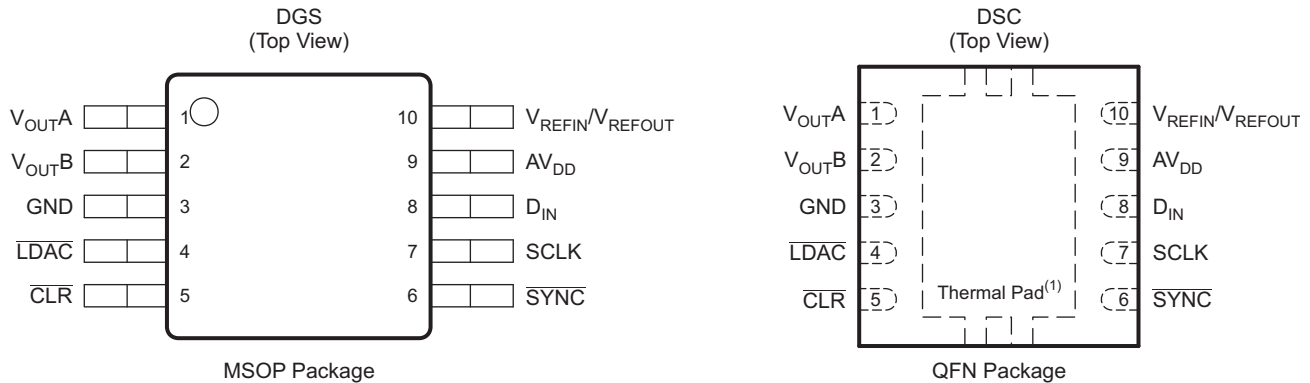

(1) It is recommended to connect the thermal pad to the ground plane for better thermal dissipation.

**Table 2. PIN DESCRIPTIONS**

| PIN                      |     | DESCRIPTION  |
|--------------------------|-----|--|
| NAME                     | NO. |  |
| $V_{DD}$                 | 9   | Power-supply input, 2.7 V to 5.5 V   |
| $\overline{CLR}$         | 5   | Asynchronous clear input. The $\overline{CLR}$ input is falling-edge sensitive. When $\overline{CLR}$ is activated, zero scale (DACxx62) or mid-scale (DACxx63) is loaded to all input and DAC registers. This sets the DAC output voltages accordingly. The part exits clear code mode on the 24 <sup>th</sup> falling edge of the next write to the part. If $\overline{CLR}$ is activated during a write sequence, the write is aborted.  |
| $D_{IN}$                 | 8   | Serial data input. Data are clocked into the 24-bit input shift register on each falling edge of the serial clock input. Schmitt-trigger logic input   |
| GND                      | 3   | Ground reference point for all circuitry on the device   |
| $\overline{LDAC}$        | 4   | In <i>synchronous</i> mode, data are updated with the falling edge of the 24 <sup>th</sup> SCLK cycle, which follows a falling edge of $\overline{SYNC}$ . For such <i>synchronous</i> updates, the $\overline{LDAC}$ pin is not required, and it must be connected to GND permanently or asserted and held low before sending commands to the device.<br>In <i>asynchronous</i> mode, the $\overline{LDAC}$ pin is used as a negative edge-triggered timing signal for simultaneous DAC updates. Multiple single-channel commands can be written in order to set different channel buffers to desired values and then make a falling edge on $\overline{LDAC}$ pin to simultaneously update the DAC output registers. |
| SCLK                     | 7   | Serial clock input. Data can be transferred at rates up to 50 MHz. Schmitt-trigger logic input   |
| $\overline{SYNC}$        | 6   | Level-triggered control input (active-low). This input is the frame synchronization signal for the input data. When $\overline{SYNC}$ goes low, it enables the input shift register, and data are sampled on subsequent falling clock edges. The DAC output updates following the 24 <sup>th</sup> clock falling edge. If $\overline{SYNC}$ is taken high before the 23 <sup>rd</sup> clock edge, the rising edge of $\overline{SYNC}$ acts as an interrupt, and the write sequence is ignored by the DAC756x/DAC816x/DAC856x. Schmitt-trigger logic input   |
| $V_{OUTA}$               | 1   | Analog output voltage from DAC-A   |
| $V_{OUTB}$               | 2   | Analog output voltage from DAC-B   |
| $V_{REFIN} / V_{REFOUT}$ | 10  | Bidirectional voltage reference pin. If internal reference is used, 2.5-V output.  |

## TIMING DIAGRAM

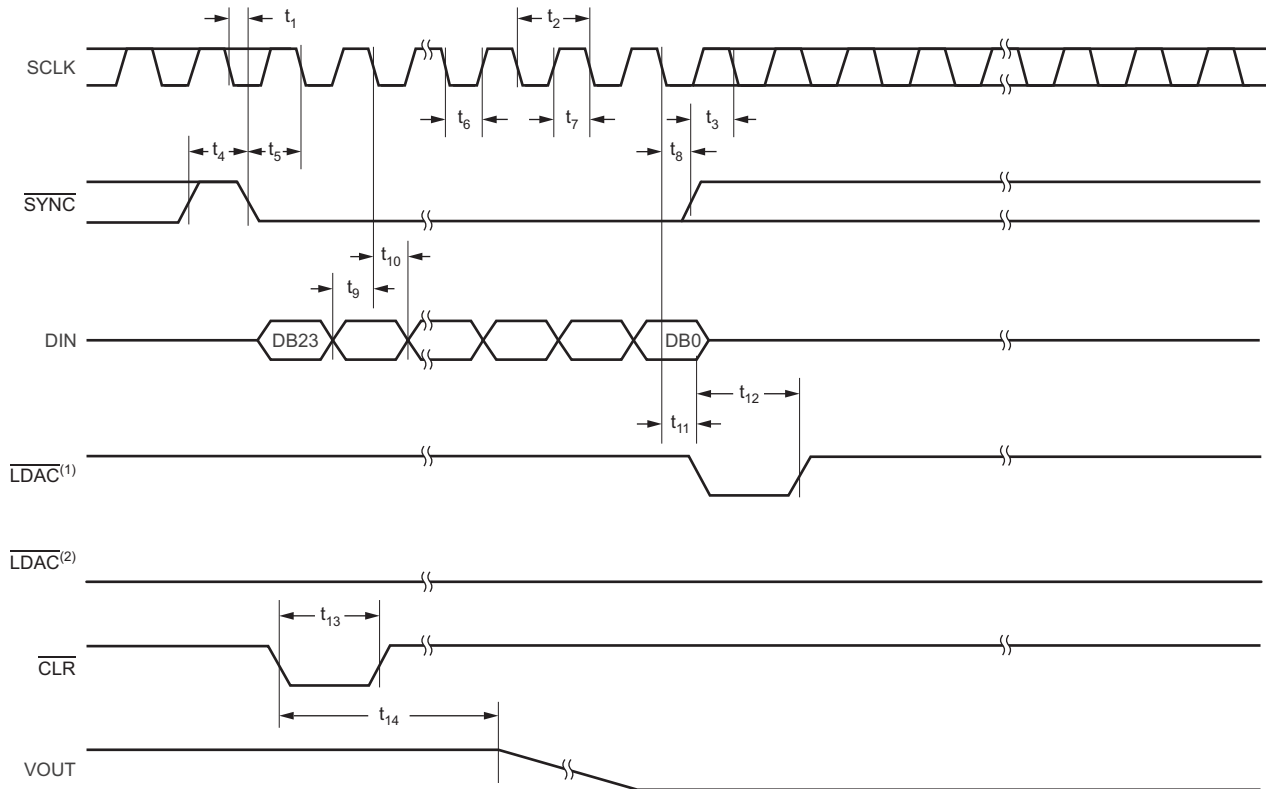

- (1) Asynchronous  $\overline{\text{LDAC}}$  update mode. For more information, see the [LDAC Functionality](#) section.  
 (2) Synchronous  $\overline{\text{LDAC}}$  update mode;  $\overline{\text{LDAC}}$  remains low. For more information, see the [LDAC Functionality](#) section.

**Figure 1. Serial Write Operation**

## TIMING REQUIREMENTS<sup>(1)(2)</sup>

At  $V_{DD} = 2.7\text{ V to }5.5\text{ V}$  and over  $-40^\circ\text{C to }125^\circ\text{C}$  (unless otherwise noted).

| PARAMETER  | DAC756x/DAC816x/DAC856x |     |     | UNIT |
|--|-------------------------|-----|-----|------|
|  | MIN                     | TYP | MAX |      |
| $t_1$ SCLK falling edge to $\overline{\text{SYNC}}$ falling edge (for successful write operation)                        | 10                      |     |     | ns   |
| $t_2^{(3)}$ SCLK cycle time  | 20                      |     |     | ns   |
| $t_3$ $\overline{\text{SYNC}}$ rising edge to 23rd SCLK falling edge (for successful $\overline{\text{SYNC}}$ interrupt) | 13                      |     |     | ns   |
| $t_4$ Minimum $\overline{\text{SYNC}}$ HIGH time   | 80                      |     |     | ns   |
| $t_5$ $\overline{\text{SYNC}}$ to SCLK falling edge setup time   | 13                      |     |     | ns   |
| $t_6$ SCLK LOW time  | 8                       |     |     | ns   |
| $t_7$ SCLK HIGH time   | 8                       |     |     | ns   |
| $t_8$ SCLK falling edge to $\overline{\text{SYNC}}$ rising edge  | 10                      |     |     | ns   |
| $t_9$ Data setup time  | 6                       |     |     | ns   |
| $t_{10}$ Data hold time  | 5                       |     |     | ns   |
| $t_{11}$ SCLK falling edge to $\overline{\text{LDAC}}$ falling edge for asynchronous LDAC update mode                    | 5                       |     |     | ns   |
| $t_{12}$ $\overline{\text{LDAC}}$ pulse duration, LOW time   | 10                      |     |     | ns   |
| $t_{13}$ $\overline{\text{CLR}}$ pulse duration, LOW time  | 80                      |     |     | ns   |
| $t_{14}$ $\overline{\text{CLR}}$ falling edge to start of VOUT transition  |                         | 100 |     | ns   |

- (1) All input signals are specified with  $t_R = t_F = 3\text{ ns}$  (10% to 90% of  $V_{DD}$ ) and timed from a voltage level of  $(V_{INL} + V_{INH})/2$ .  
 (2) See the *Serial Write Operation* timing diagram (Figure 1).  
 (3) Maximum SCLK frequency is 50 MHz at  $V_{DD} = 2.7\text{ V to }5.5\text{ V}$ .

## TABLES OF GRAPHS

**Table 3. Typical Characteristics: Internal Reference Performance**

| MEASUREMENT  | POWER-SUPPLY VOLTAGE | FIGURE NUMBER            |
|--|----------------------|--------------------------|
| Internal Reference Voltage vs Temperature              | 5.5 V                | <a href="#">Figure 2</a> |
| Internal Reference Voltage Temperature Drift Histogram |                      | <a href="#">Figure 3</a> |
| Internal Reference Voltage vs Load Current             |                      | <a href="#">Figure 4</a> |
| Internal Reference Voltage vs Time                     |                      | <a href="#">Figure 5</a> |
| Internal Reference Noise Density vs Frequency          |                      | <a href="#">Figure 6</a> |
| Internal Reference Voltage vs Supply Voltage           | 2.7 V – 5.5 V        | <a href="#">Figure 7</a> |

**Table 4. Typical Characteristics: DAC Static Performance**

| MEASUREMENT  | POWER-SUPPLY VOLTAGE | FIGURE NUMBER                          |
|--|----------------------|--|
| <b>FULL-SCALE, GAIN, OFFSET AND ZERO-CODE ERRORS</b>   |                      |  |
| Full-Scale Error vs Temperature                        | 5.5 V                | <a href="#">Figure 16</a>              |
| Gain Error vs Temperature                              |                      | <a href="#">Figure 17</a>              |
| Offset Error vs Temperature                            |                      | <a href="#">Figure 18</a>              |
| Zero-Code Error vs Temperature                         |                      | <a href="#">Figure 19</a>              |
| Full-Scale Error vs Temperature                        | 2.7 V                | <a href="#">Figure 63</a>              |
| Gain Error vs Temperature                              |                      | <a href="#">Figure 64</a>              |
| Offset Error vs Temperature                            |                      | <a href="#">Figure 65</a>              |
| Zero-Code Error vs Temperature                         |                      | <a href="#">Figure 66</a>              |
| <b>LOAD REGULATION</b>                                 |                      |  |
| DAC Output Voltage vs Load Current                     | 5.5 V                | <a href="#">Figure 30</a>              |
|  | 2.7 V                | <a href="#">Figure 74</a>              |
| <b>DIFFERENTIAL NONLINEARITY ERROR</b>                 |                      |  |
| Differential Linearity Error vs Digital Input Code     | 5.5 V                | T = –40°C<br><a href="#">Figure 9</a>  |
|  |                      | T = 25°C<br><a href="#">Figure 11</a>  |
|  |                      | T = 125°C<br><a href="#">Figure 13</a> |
| Differential Linearity Error vs Temperature            |                      | <a href="#">Figure 15</a>              |
| Differential Linearity Error vs Digital Input Code     | 2.7 V                | T = –40°C<br><a href="#">Figure 56</a> |
|  |                      | T = 25°C<br><a href="#">Figure 58</a>  |
|  |                      | T = 125°C<br><a href="#">Figure 60</a> |
| Differential Linearity Error vs Temperature            |                      | <a href="#">Figure 62</a>              |
| <b>INTEGRAL NONLINEARITY ERROR (RELATIVE ACCURACY)</b> |                      |  |
| Linearity Error vs Digital Input Code                  | 5.5 V                | T = –40°C<br><a href="#">Figure 8</a>  |
|  |                      | T = 25°C<br><a href="#">Figure 10</a>  |
|  |                      | T = 125°C<br><a href="#">Figure 12</a> |
| Linearity Error vs Temperature                         |                      | <a href="#">Figure 14</a>              |
| Linearity Error vs Digital Input Code                  | 2.7 V                | T = –40°C<br><a href="#">Figure 55</a> |
|  |                      | T = 25°C<br><a href="#">Figure 57</a>  |
|  |                      | T = 125°C<br><a href="#">Figure 59</a> |
| Linearity Error vs Temperature                         |                      | <a href="#">Figure 61</a>              |



**Table 4. Typical Characteristics: DAC Static Performance (continued)**

| MEASUREMENT                                  |                    | POWER-SUPPLY VOLTAGE      | FIGURE NUMBER             |                           |
|--|--------------------|---------------------------|---------------------------|---------------------------|
| <b>POWER-DOWN CURRENT</b>                    |                    |                           |                           |                           |
| Power-Down Current vs Temperature            |                    | 5.5 V                     | <a href="#">Figure 28</a> |                           |
| Power-Down Current vs Power-Supply Voltage   |                    | 2.7 V – 5.5 V             | <a href="#">Figure 29</a> |                           |
| Power-Down Current vs Temperature            |                    | 2.7 V                     | <a href="#">Figure 73</a> |                           |
| <b>POWER-SUPPLY CURRENT</b>                  |                    |                           |                           |                           |
| Power-Supply Current vs Temperature          | External $V_{REF}$ | 5.5 V                     | <a href="#">Figure 20</a> |                           |
|  | Internal $V_{REF}$ |                           | <a href="#">Figure 21</a> |                           |
| Power-Supply Current vs Digital Input Code   | External $V_{REF}$ |                           | <a href="#">Figure 22</a> |                           |
|  | Internal $V_{REF}$ |                           | <a href="#">Figure 23</a> |                           |
| Power-Supply Current Histogram               | External $V_{REF}$ |                           | <a href="#">Figure 24</a> |                           |
|  | Internal $V_{REF}$ |                           | <a href="#">Figure 25</a> |                           |
| Power-Supply Current vs Power-Supply Voltage | External $V_{REF}$ |                           | 2.7 V – 5.5 V             | <a href="#">Figure 26</a> |
|  | Internal $V_{REF}$ |                           |                           | <a href="#">Figure 27</a> |
| Power-Supply Current vs Temperature          | External $V_{REF}$ |                           | 3.6 V                     | <a href="#">Figure 49</a> |
|  | Internal $V_{REF}$ |                           |                           | <a href="#">Figure 50</a> |
| Power-Supply Current vs Digital Input Code   | External $V_{REF}$ | <a href="#">Figure 51</a> |                           |                           |
|  | Internal $V_{REF}$ | <a href="#">Figure 52</a> |                           |                           |
| Power-Supply Current Histogram               | External $V_{REF}$ | <a href="#">Figure 53</a> |                           |                           |
|  | Internal $V_{REF}$ | <a href="#">Figure 54</a> |                           |                           |
| Power-Supply Current vs Temperature          | External $V_{REF}$ | 2.7 V                     |                           | <a href="#">Figure 67</a> |
|  | Internal $V_{REF}$ |                           |                           | <a href="#">Figure 68</a> |
| Power-Supply Current vs Digital Input Code   | External $V_{REF}$ |                           |                           | <a href="#">Figure 69</a> |
|  | Internal $V_{REF}$ |                           |                           | <a href="#">Figure 70</a> |
| Power-Supply Current Histogram               | External $V_{REF}$ |                           | <a href="#">Figure 71</a> |                           |
|  | Internal $V_{REF}$ |                           | <a href="#">Figure 72</a> |                           |

**Table 5. Typical Characteristics: DAC Dynamic Performance**

| MEASUREMENT                           |                                   | POWER-SUPPLY VOLTAGE | FIGURE NUMBER |           |
|---------------------------------------|-----------------------------------|----------------------|---------------|-----------|
| <b>CHANNEL-TO-CHANNEL CROSSTALK</b>   |                                   |                      |               |           |
| Channel-to-Channel Crosstalk          | 5-V Rising Edge                   | 5.5 V                | Figure 43     |           |
|                                       | 5-V Falling Edge                  |                      | Figure 44     |           |
| <b>CLOCK FEEDTHROUGH</b>              |                                   |                      |               |           |
| Clock Feedthrough                     | 500 kHz, Midscale                 | 5.5 V                | Figure 48     |           |
|                                       |                                   | 2.7 V                | Figure 87     |           |
| <b>GLITCH ENERGY</b>                  |                                   |                      |               |           |
| Glitch Energy, 1-LSB Step             | Rising Edge, Code 7FFFh to 8000h  | 5.5 V                | Figure 37     |           |
|                                       | Falling Edge, Code 8000h to 7FFFh |                      | Figure 38     |           |
| Glitch Energy, 4-LSB Step             | Rising Edge, Code 7FFCh to 8000h  |                      | Figure 39     |           |
|                                       | Falling Edge, Code 8000h to 7FFCh |                      | Figure 40     |           |
| Glitch Energy, 16-LSB Step            | Rising Edge, Code 7FF0h to 8000h  |                      | Figure 41     |           |
|                                       | Falling Edge, Code 8000h to 7FF0h |                      | Figure 42     |           |
| Glitch Energy, 1-LSB Step             | Rising Edge, Code 7FFFh to 8000h  |                      | 2.7 V         | Figure 79 |
|                                       | Falling Edge, Code 8000h to 7FFFh |                      |               | Figure 80 |
| Glitch Energy, 4-LSB Step             | Rising Edge, Code 7FFCh to 8000h  | Figure 81            |               |           |
|                                       | Falling Edge, Code 8000h to 7FFCh | Figure 82            |               |           |
| Glitch Energy, 16-LSB Step            | Rising Edge, Code 7FF0h to 8000h  | Figure 83            |               |           |
|                                       | Falling Edge, Code 8000h to 7FF0h | Figure 84            |               |           |
| <b>NOISE</b>                          |                                   |                      |               |           |
| DAC Output Noise Density vs Frequency | External $V_{REF}$                | 5.5 V                |               | Figure 45 |
|                                       | Internal $V_{REF}$                |                      | Figure 46     |           |
| DAC Output Noise 0.1 Hz to 10 Hz      | External $V_{REF}$                |                      | Figure 47     |           |
| <b>POWER-ON GLITCH</b>                |                                   |                      |               |           |
| Power-on Glitch                       | Reset to Zero Scale               | 5.5 V                | Figure 35     |           |
|                                       | Reset to Midscale                 |                      | Figure 36     |           |
|                                       | Reset to Zero Scale               | 2.7 V                | Figure 85     |           |
|                                       | Reset to Midscale                 |                      | Figure 86     |           |
| <b>SETTLING TIME</b>                  |                                   |                      |               |           |
| Full-Scale Settling Time              | Rising Edge, Code 0h to FFFFh     | 5.5 V                | Figure 31     |           |
|                                       | Falling Edge, Code FFFFh to 0h    |                      | Figure 32     |           |
| Half-Scale Settling Time              | Rising Edge, Code 4000h to C000h  |                      | Figure 33     |           |
|                                       | Falling Edge, Code C000h to 4000h |                      | Figure 34     |           |
| Full-Scale Settling Time              | Rising Edge, Code 0h to FFFFh     | 2.7 V                | Figure 75     |           |
|                                       | Falling Edge, Code FFFFh to 0h    |                      | Figure 76     |           |
| Half-Scale Settling Time              | Rising Edge, Code 4000h to C000h  |                      | Figure 77     |           |
|                                       | Falling Edge, Code C000h to 4000h |                      | Figure 78     |           |

**TYPICAL CHARACTERISTICS: Internal Reference**

At  $T_A = 25^\circ\text{C}$ ,  $AV_{DD} = 5.5\text{ V}$ , gain = 2 and  $V_{REFOUT}$ , unloaded unless otherwise noted.

**INTERNAL REFERENCE VOLTAGE vs TEMPERATURE**

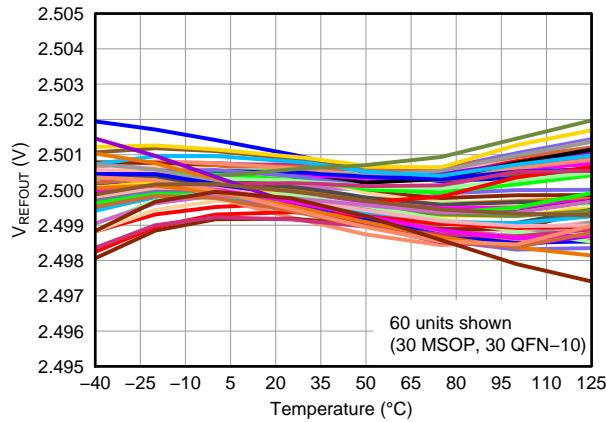

Figure 2.

**INTERNAL REFERENCE VOLTAGE TEMPERATURE DRIFT HISTOGRAM**

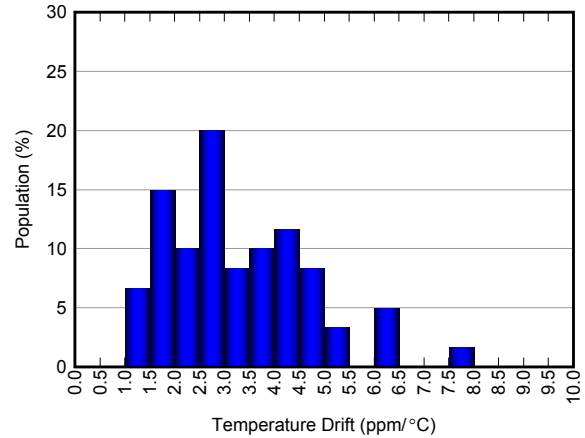

Figure 3.

**INTERNAL REFERENCE VOLTAGE vs LOAD CURRENT**

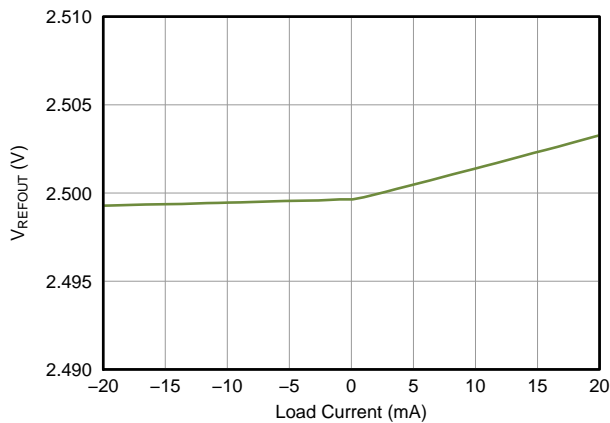

Figure 4.

**INTERNAL REFERENCE VOLTAGE vs TIME**

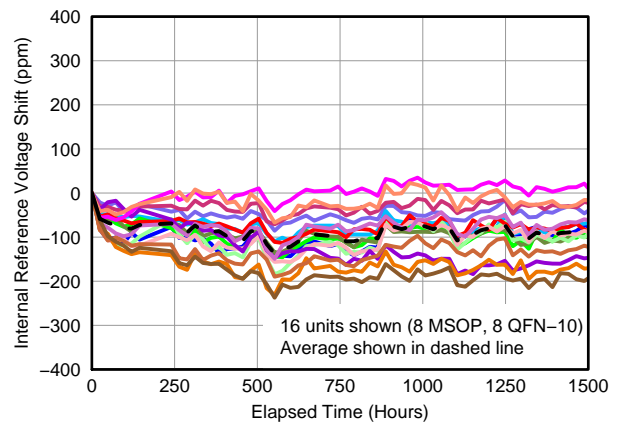

Figure 5.

**INTERNAL REFERENCE NOISE DENSITY vs FREQUENCY**

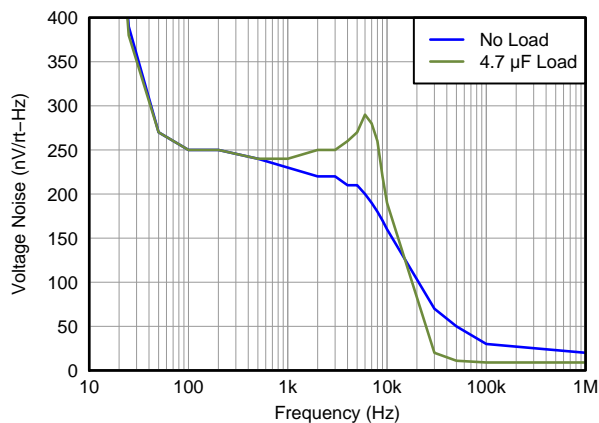

Figure 6.

**INTERNAL REFERENCE VOLTAGE vs SUPPLY VOLTAGE**

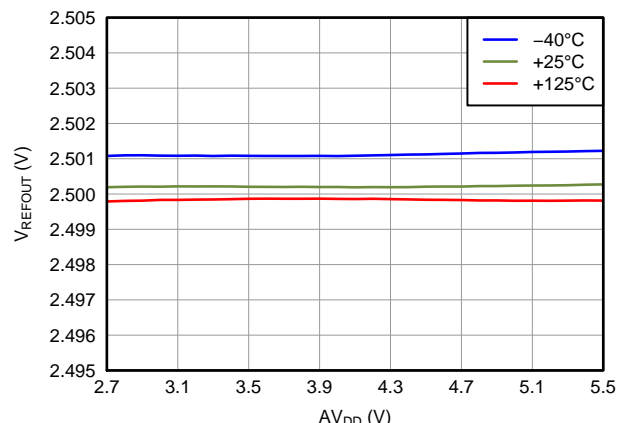
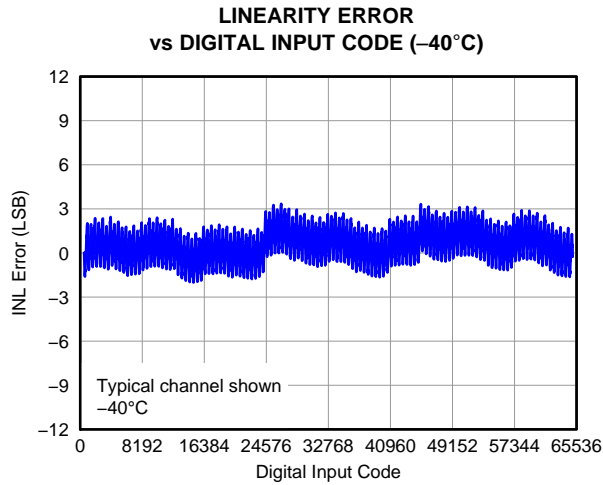

Figure 7.

**TYPICAL CHARACTERISTICS: DAC at  $V_{DD} = 5.5\text{ V}$**

At  $T_A = 25^\circ\text{C}$ , 5-V external reference used, gain = 1 and DAC output not loaded, unless otherwise noted.



**Figure 8.**

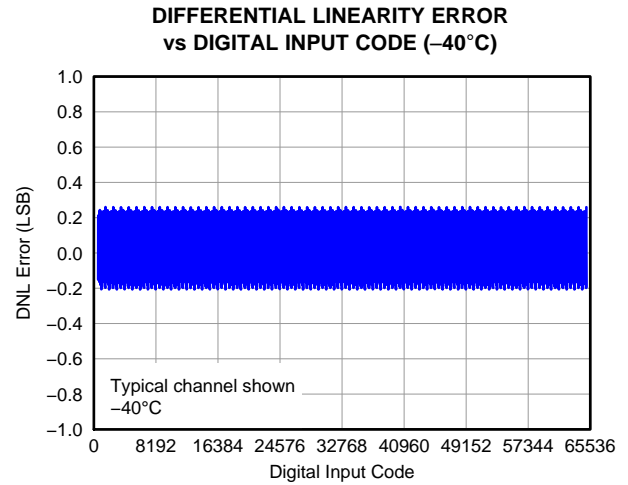

**Figure 9.**

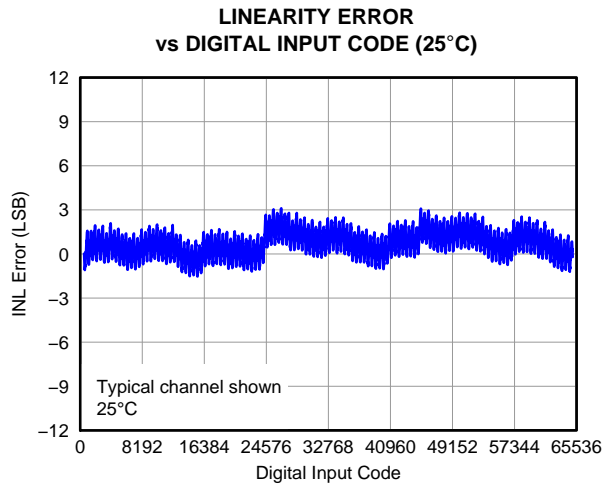

**Figure 10.**

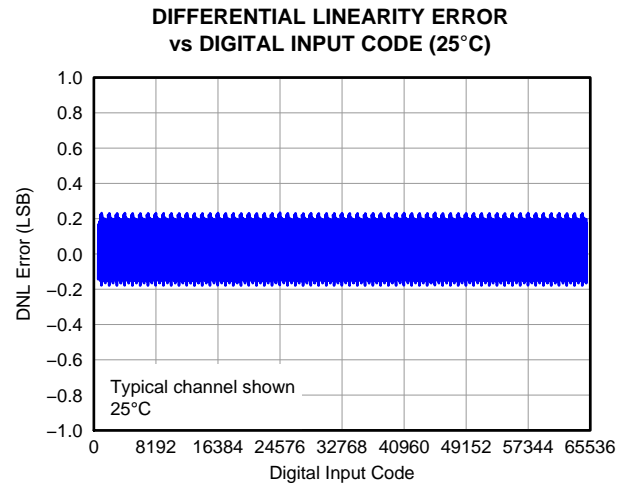

**Figure 11.**

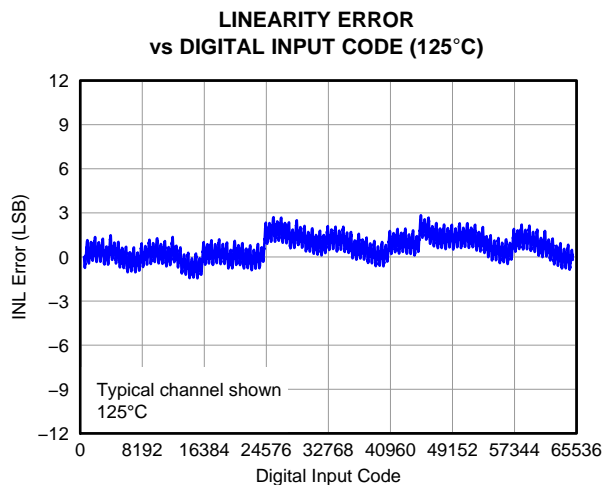

**Figure 12.**

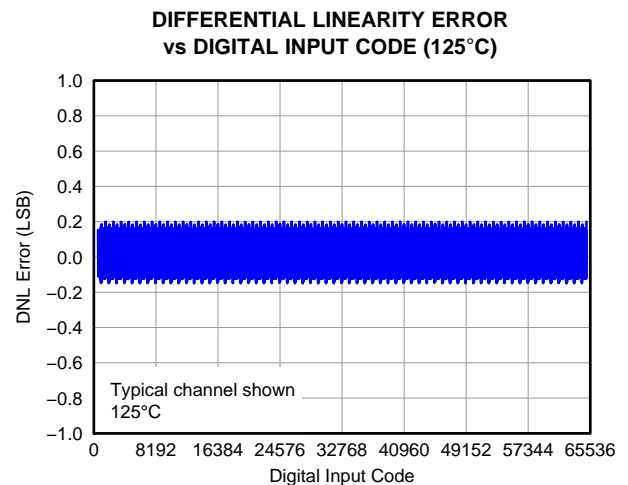
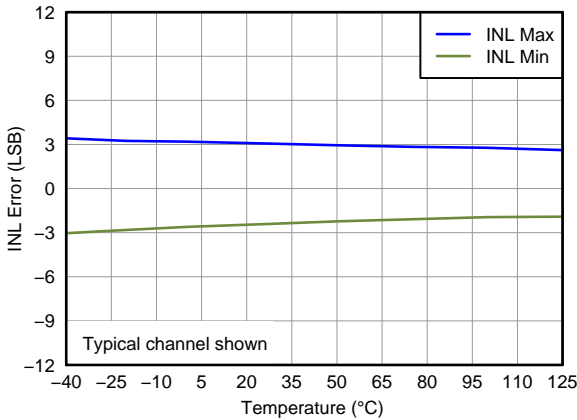

**Figure 13.**

**TYPICAL CHARACTERISTICS: DAC at AV<sub>DD</sub> = 5.5 V (continued)**

At T<sub>A</sub> = 25°C, 5-V external reference used, gain = 1 and DAC output not loaded, unless otherwise noted.

**LINEARITY ERROR vs TEMPERATURE**



**Figure 14.**

**DIFFERENTIAL LINEARITY ERROR vs TEMPERATURE**

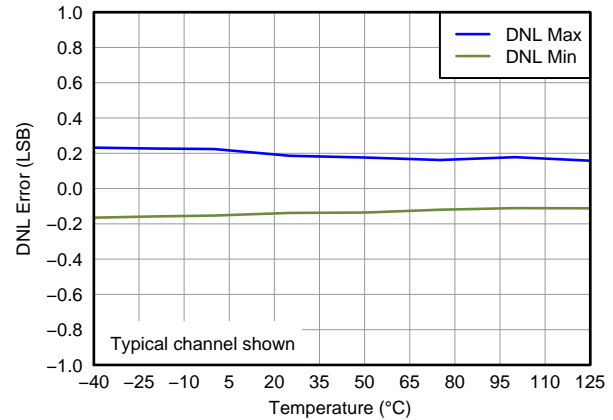

**Figure 15.**

**FULL-SCALE ERROR vs TEMPERATURE**

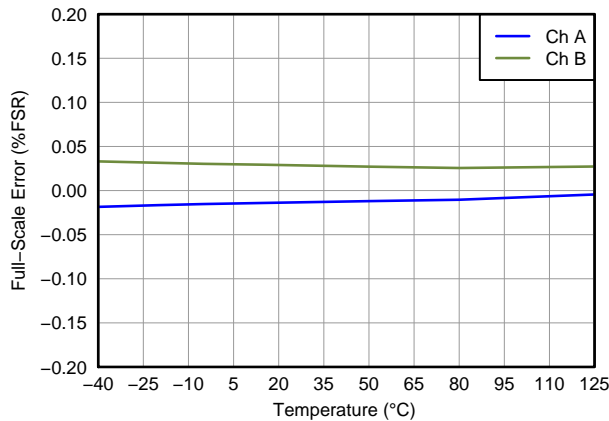

**Figure 16.**

**GAIN ERROR vs TEMPERATURE**

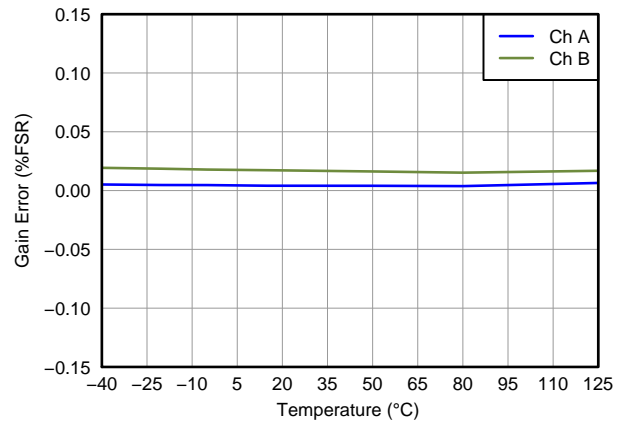

**Figure 17.**

**OFFSET ERROR vs TEMPERATURE**

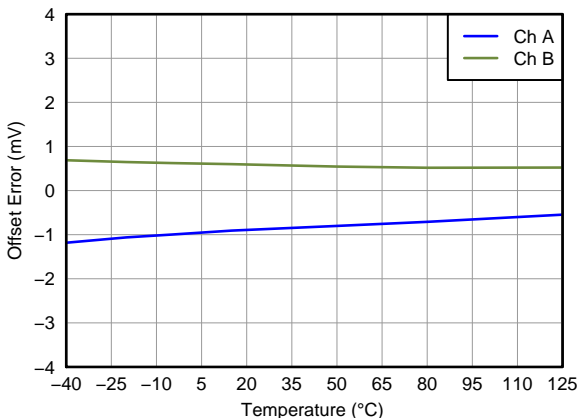

**Figure 18.**

**ZERO-CODE ERROR vs TEMPERATURE**

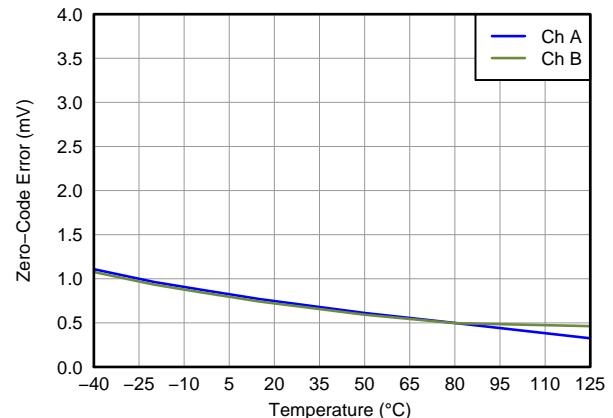
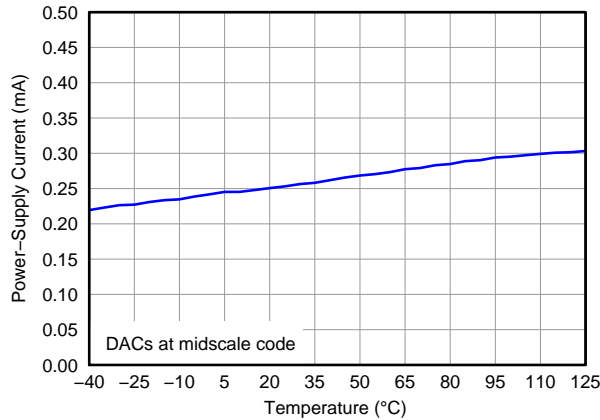

**Figure 19.**

**TYPICAL CHARACTERISTICS: DAC at  $V_{DD} = 5.5\text{ V}$  (continued)**

At  $T_A = 25^\circ\text{C}$ , 5-V external reference used, gain = 1 and DAC output not loaded, unless otherwise noted.

**POWER-SUPPLY CURRENT  
vs TEMPERATURE**



**Figure 20.**

**POWER-SUPPLY CURRENT  
vs TEMPERATURE**

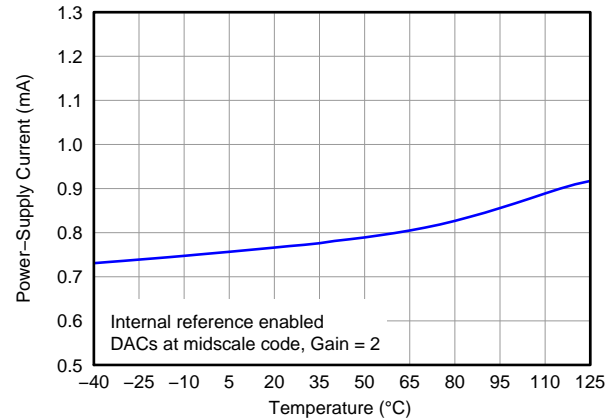

**Figure 21.**

**POWER-SUPPLY CURRENT  
vs DIGITAL INPUT CODE**

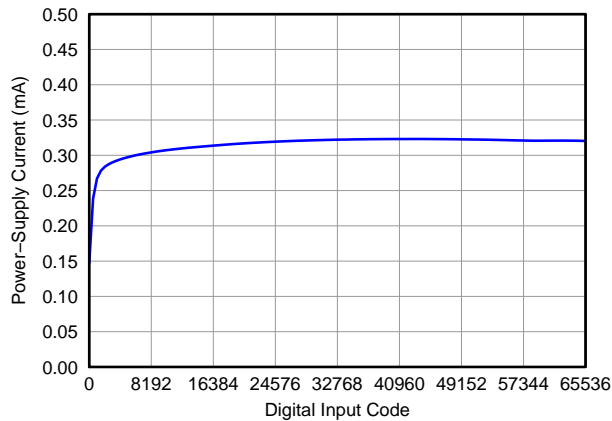

**Figure 22.**

**POWER-SUPPLY CURRENT  
vs DIGITAL INPUT CODE**

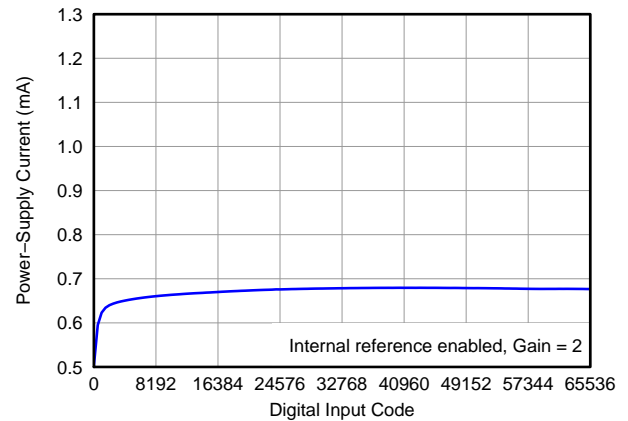

**Figure 23.**

**POWER-SUPPLY CURRENT  
HISTOGRAM**

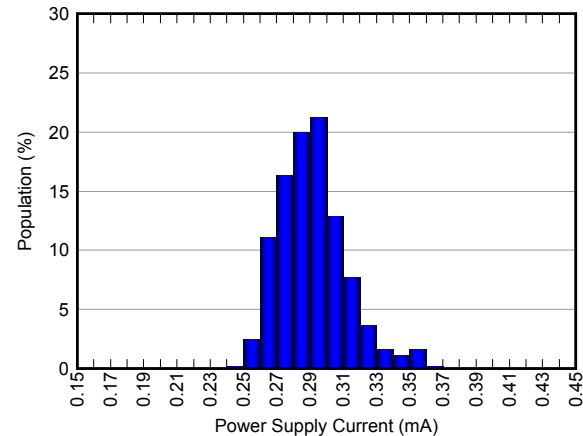

**Figure 24.**

**POWER-SUPPLY CURRENT  
HISTOGRAM**

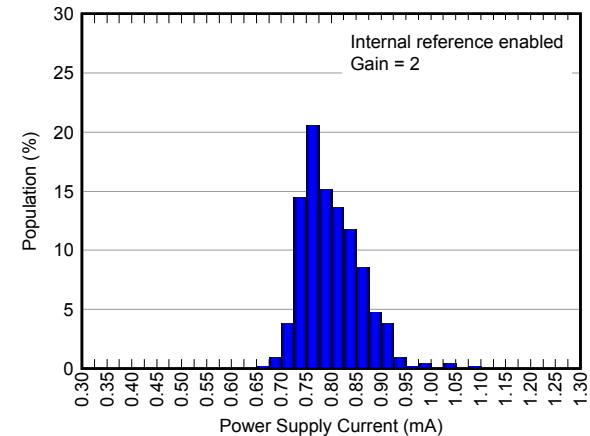

**Figure 25.**

**TYPICAL CHARACTERISTICS: DAC at  $V_{DD} = 5.5\text{ V}$  (continued)**

At  $T_A = 25^\circ\text{C}$ , 5-V external reference used, gain = 1 and DAC output not loaded, unless otherwise noted.

**POWER-SUPPLY CURRENT vs POWER-SUPPLY VOLTAGE**

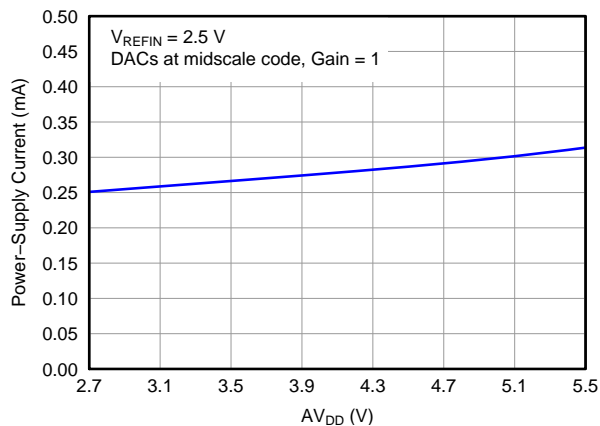

Figure 26.

**POWER-SUPPLY CURRENT vs POWER-SUPPLY VOLTAGE**

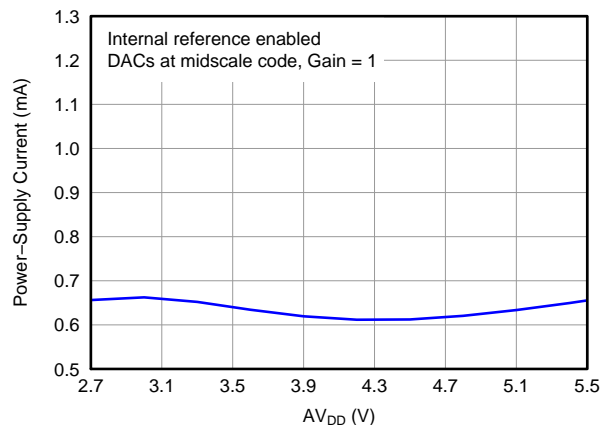

Figure 27.

**POWER-DOWN CURRENT vs TEMPERATURE**

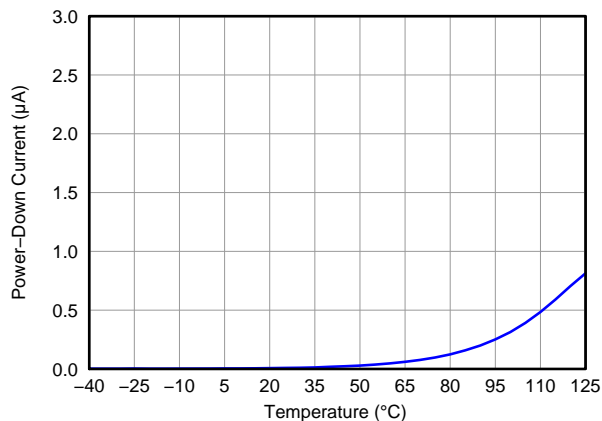

Figure 28.

**POWER-DOWN CURRENT vs POWER-SUPPLY VOLTAGE**

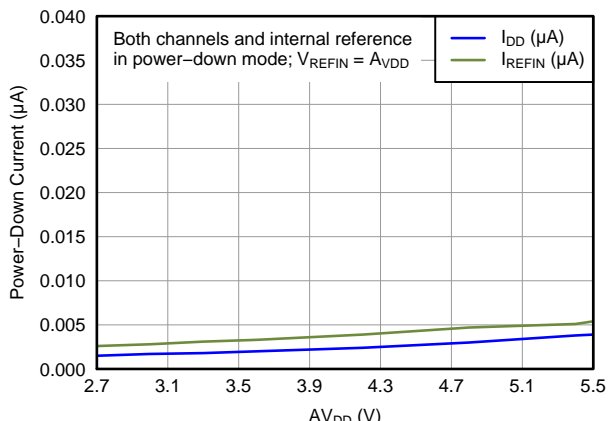

Figure 29.

**DAC OUTPUT VOLTAGE vs LOAD CURRENT**

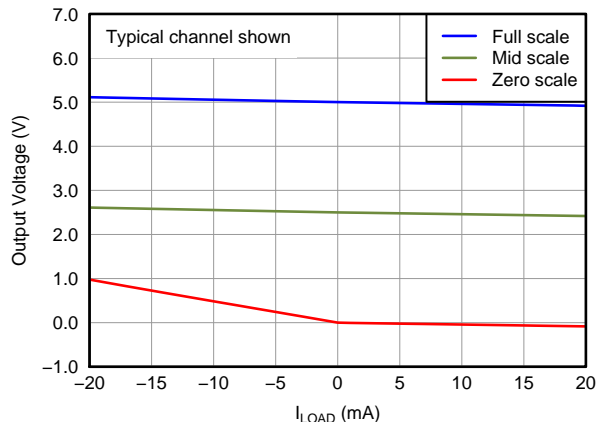
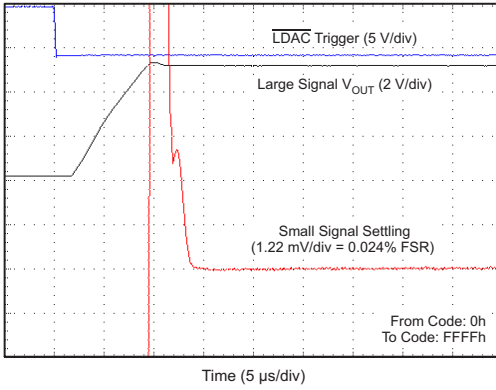

Figure 30.

**TYPICAL CHARACTERISTICS: DAC at  $V_{DD} = 5.5\text{ V}$  (continued)**

At  $T_A = 25^\circ\text{C}$ , 5-V external reference used, gain = 1 and DAC output not loaded, unless otherwise noted.

**FULL-SCALE SETTLING TIME:  
RISING EDGE**



**Figure 31.**

**FULL-SCALE SETTLING TIME:  
FALLING EDGE**

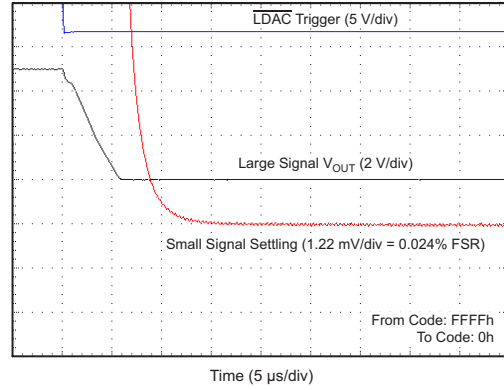

**Figure 32.**

**HALF-SCALE SETTLING TIME:  
RISING EDGE**

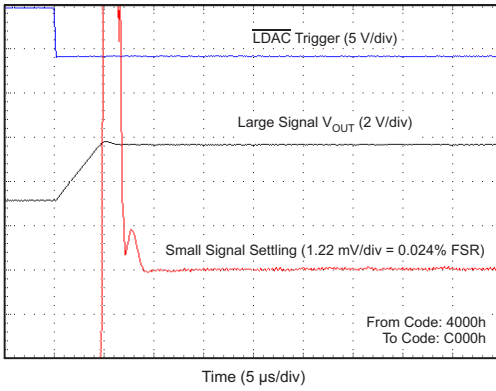

**Figure 33.**

**HALF-SCALE SETTLING TIME:  
FALLING EDGE**

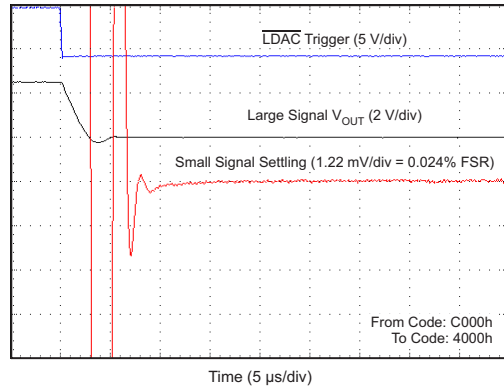

**Figure 34.**

**POWER-ON GLITCH  
RESET TO ZERO SCALE**

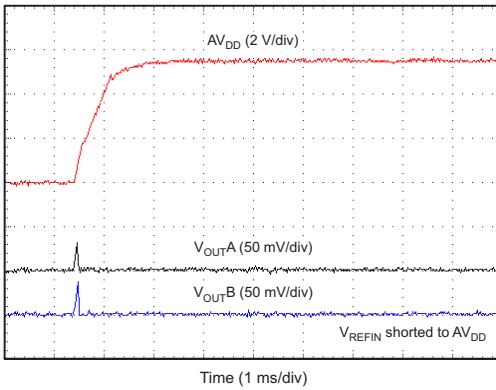

**Figure 35.**

**POWER-ON GLITCH  
RESET TO MIDSACLE**

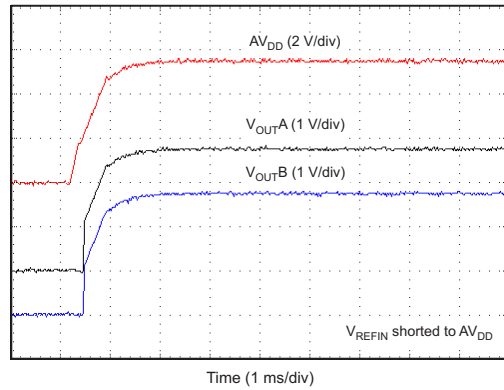

**Figure 36.**



**TYPICAL CHARACTERISTICS: DAC at  $V_{DD} = 5.5\text{ V}$  (continued)**

At  $T_A = 25^\circ\text{C}$ , 5-V external reference used, gain = 1 and DAC output not loaded, unless otherwise noted.

**GLITCH ENERGY  
 RISING EDGE, 1-LSB STEP**

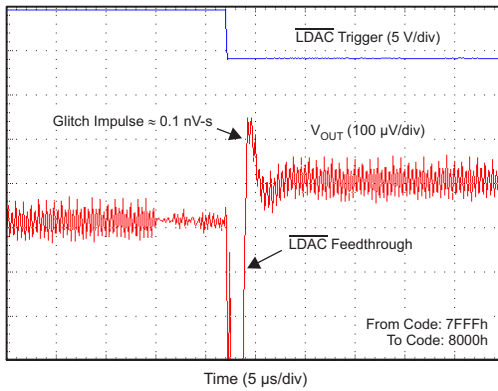

Figure 37.

**GLITCH ENERGY  
 FALLING EDGE, 1-LSB STEP**

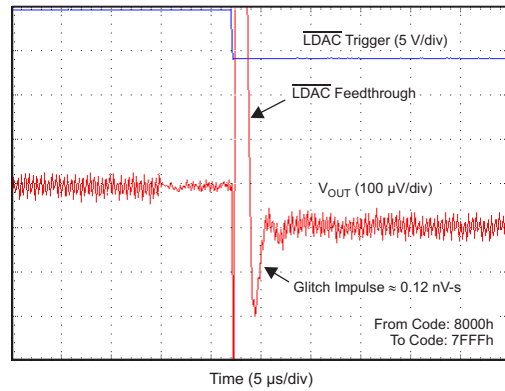

Figure 38.

**GLITCH ENERGY  
 RISING EDGE, 4-LSB STEP**

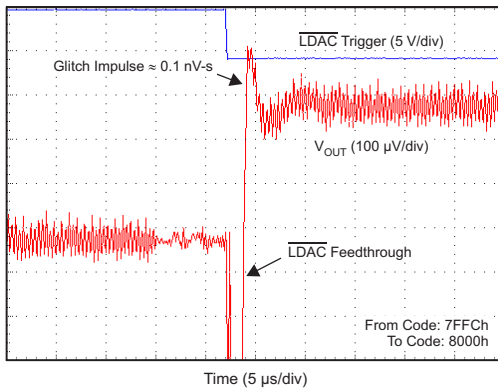

Figure 39.

**GLITCH ENERGY  
 FALLING EDGE, 4-LSB STEP**

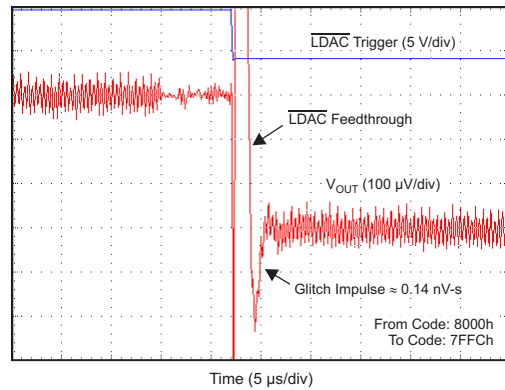

Figure 40.

**GLITCH ENERGY  
 RISING EDGE, 16-LSB STEP**

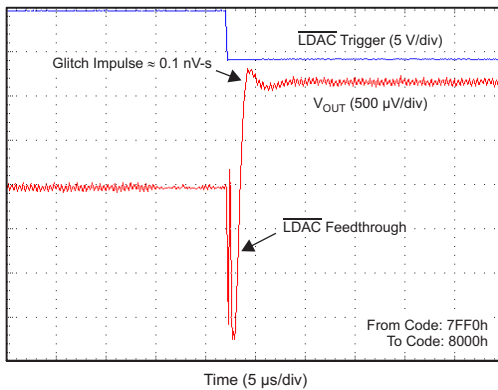

Figure 41.

**GLITCH ENERGY  
 FALLING EDGE, 16-LSB STEP**

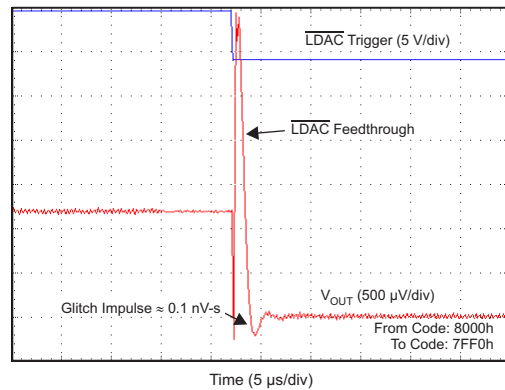
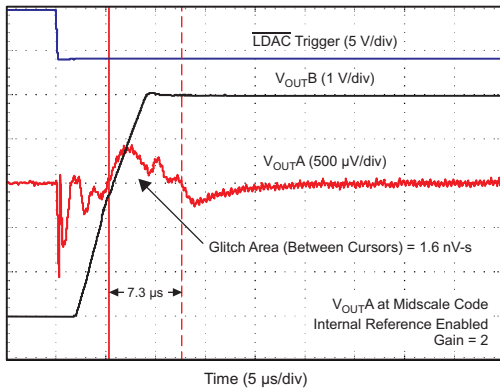

Figure 42.

**TYPICAL CHARACTERISTICS: DAC at  $V_{DD} = 5.5\text{ V}$  (continued)**

At  $T_A = 25^\circ\text{C}$ , 5-V external reference used, gain = 1 and DAC output not loaded, unless otherwise noted.

**CHANNEL-TO-CHANNEL CROSSTALK  
5-V RISING EDGE**



**Figure 43.**

**CHANNEL-TO-CHANNEL CROSSTALK  
5-V FALLING EDGE**

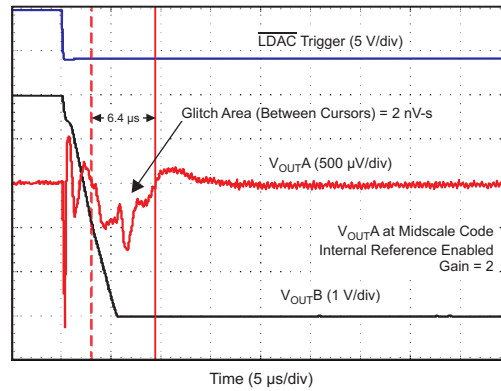

**Figure 44.**

**DAC OUTPUT NOISE DENSITY  
vs FREQUENCY**

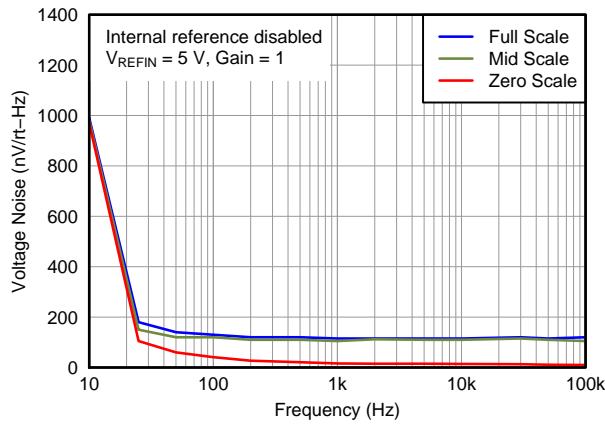

**Figure 45.**

**DAC OUTPUT NOISE DENSITY  
vs FREQUENCY**

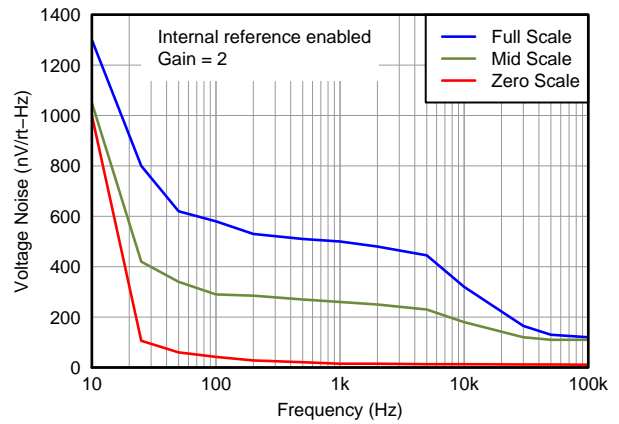

**Figure 46.**

**DAC OUTPUT NOISE  
0.1 Hz TO 10 Hz**

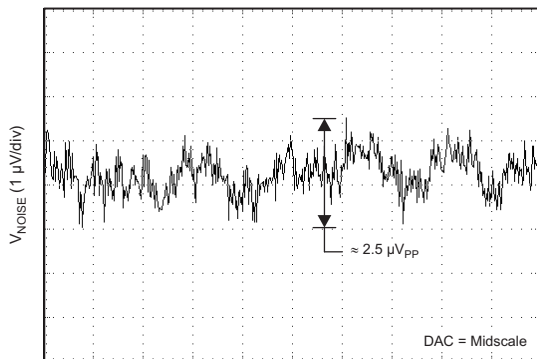

**Figure 47.**

**CLOCK FEEDTHROUGH  
500 kHz, MIDSACLE**

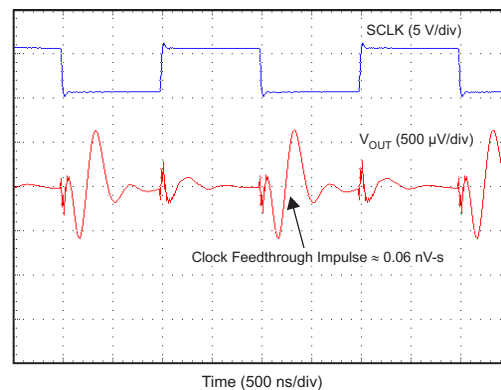

**Figure 48.**

**TYPICAL CHARACTERISTICS: DAC at  $V_{DD} = 3.6\text{ V}$**

At  $T_A = 25^\circ\text{C}$ , 3.3-V external reference used, gain = 1 and DAC output not loaded, unless otherwise noted.

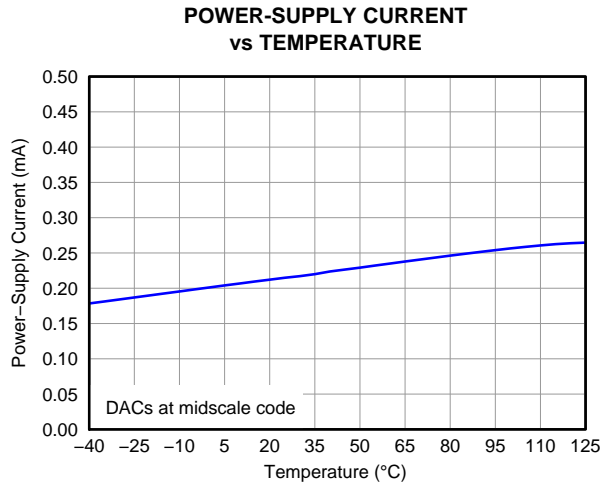

Figure 49.

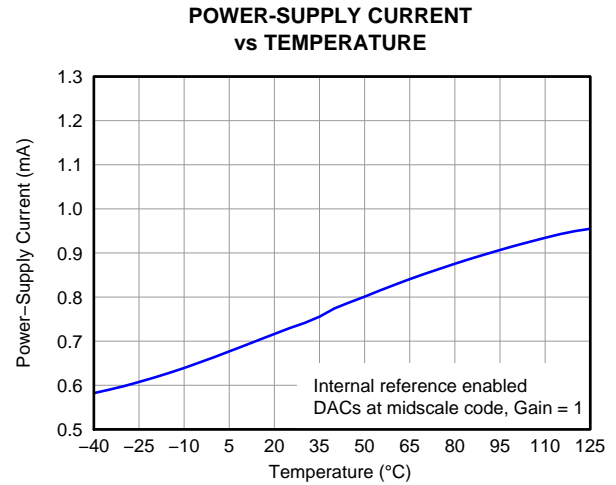

Figure 50.

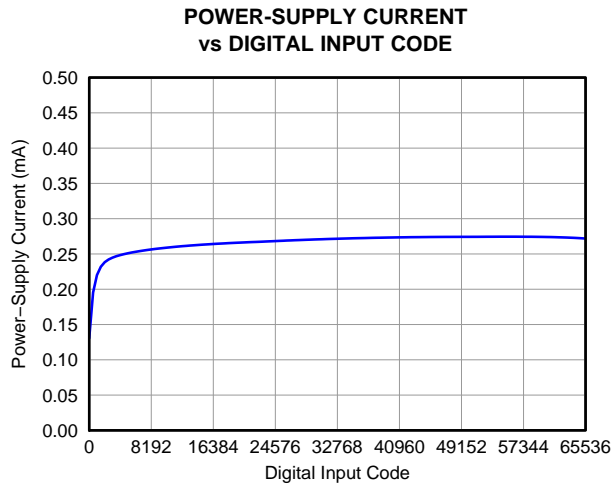

Figure 51.

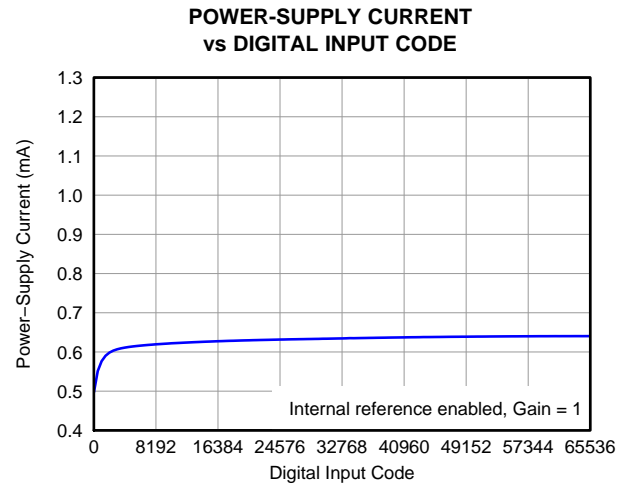

Figure 52.

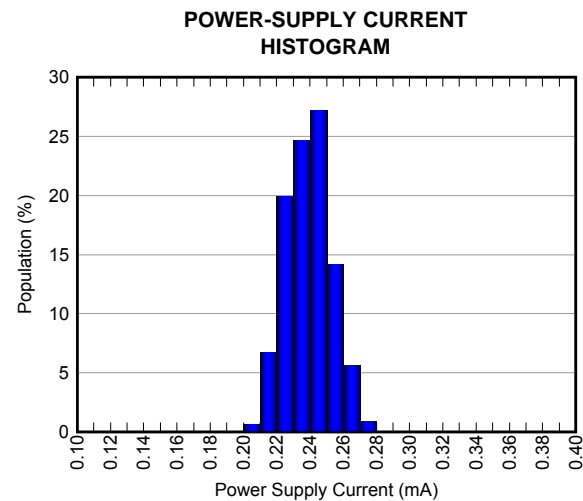

Figure 53.

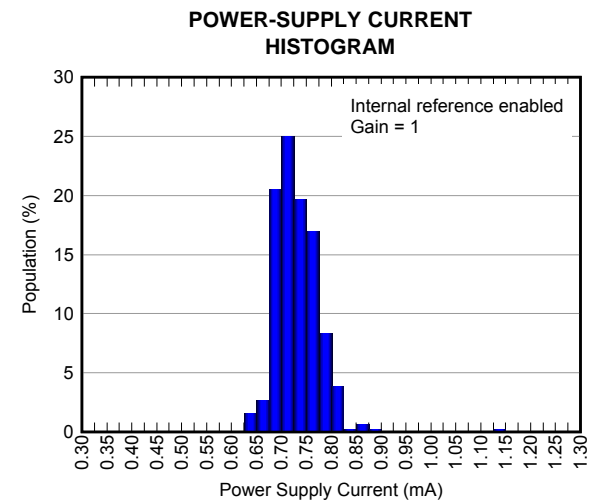
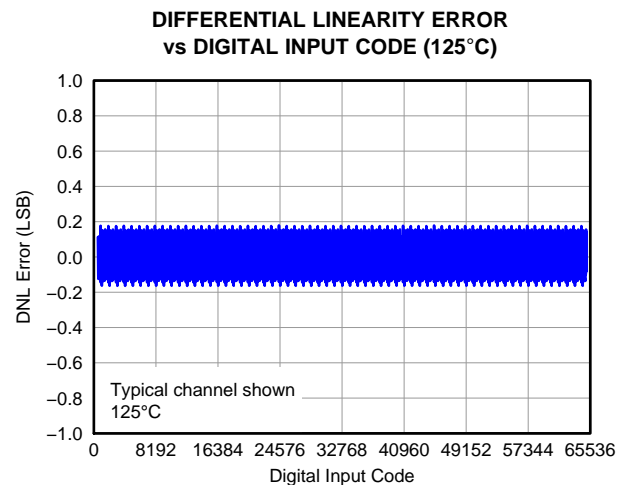
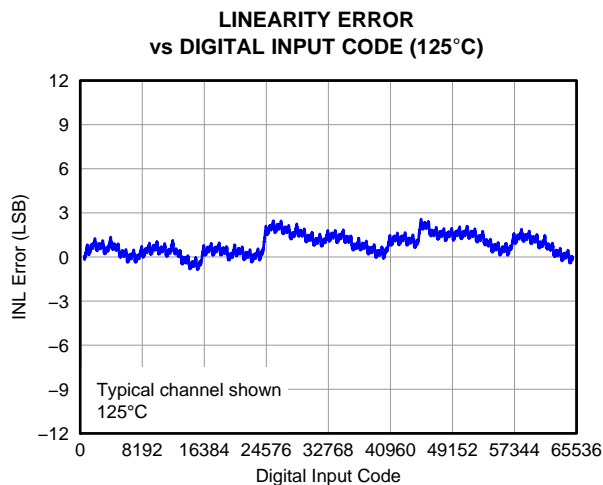
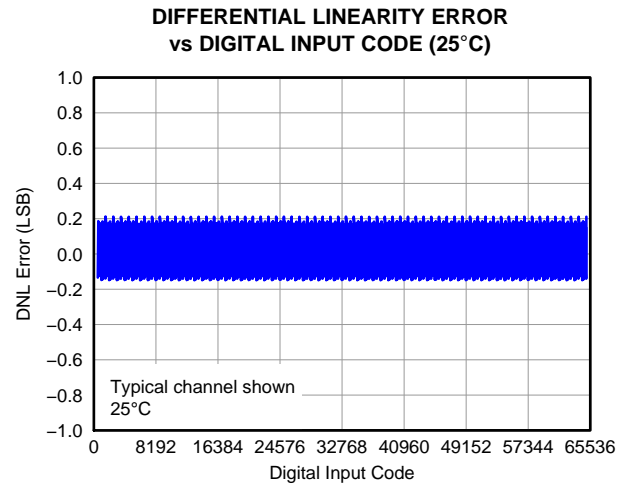
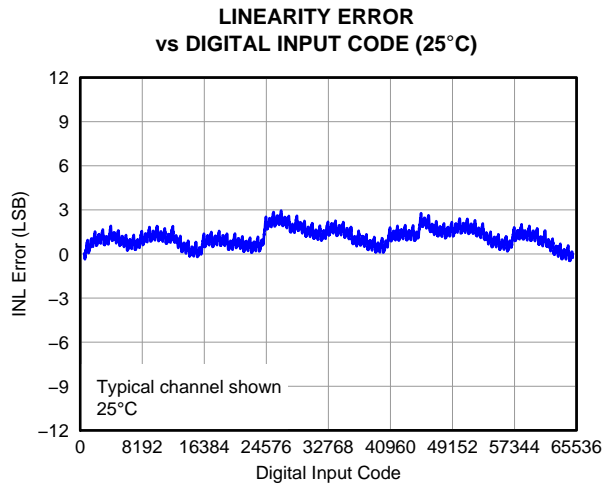
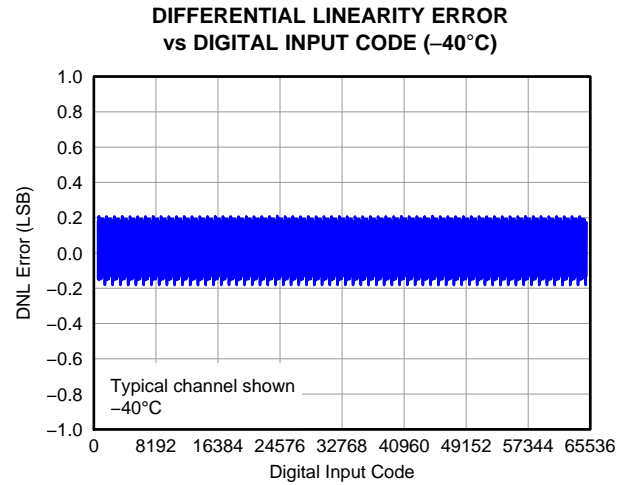
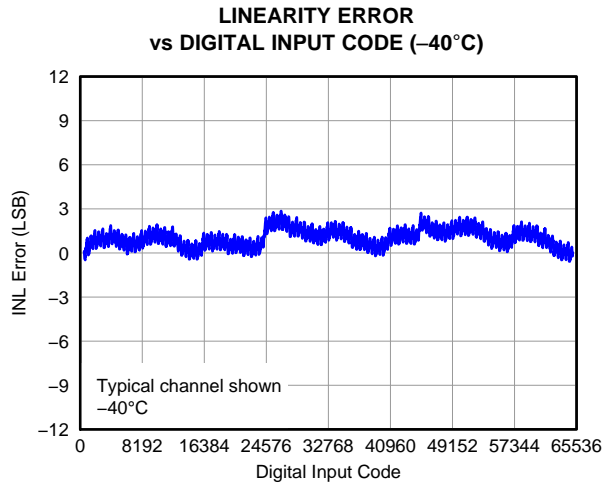

Figure 54.

**TYPICAL CHARACTERISTICS: DAC at  $V_{DD} = 2.7\text{ V}$**

At  $T_A = 25^\circ\text{C}$ , 2.5-V external reference used, gain = 1 and DAC output not loaded, unless otherwise noted.



**TYPICAL CHARACTERISTICS: DAC at AV<sub>DD</sub> = 2.7 V (continued)**

At T<sub>A</sub> = 25°C, 2.5-V external reference used, gain = 1 and DAC output not loaded, unless otherwise noted.

**LINEARITY ERROR vs TEMPERATURE**

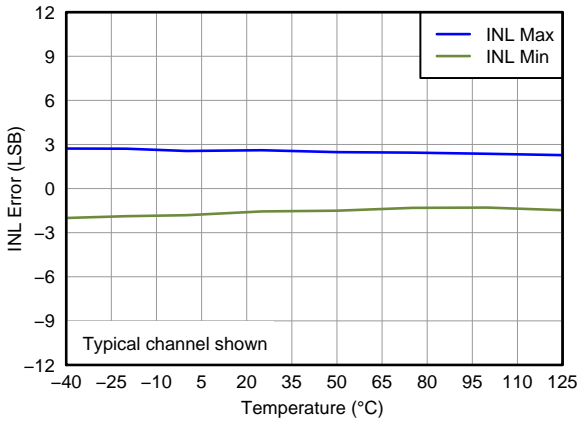

Figure 61.

**DIFFERENTIAL LINEARITY ERROR vs TEMPERATURE**

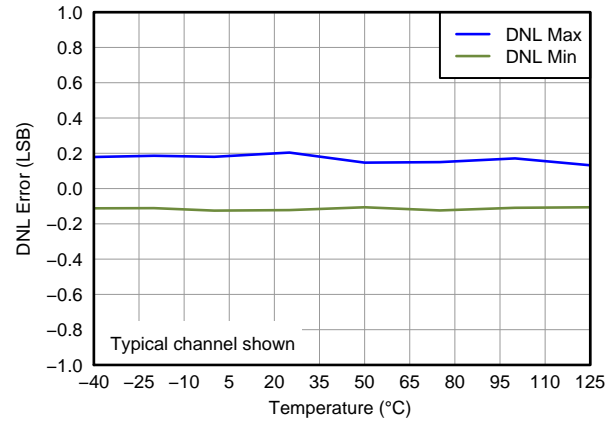

Figure 62.

**FULL-SCALE ERROR vs TEMPERATURE**

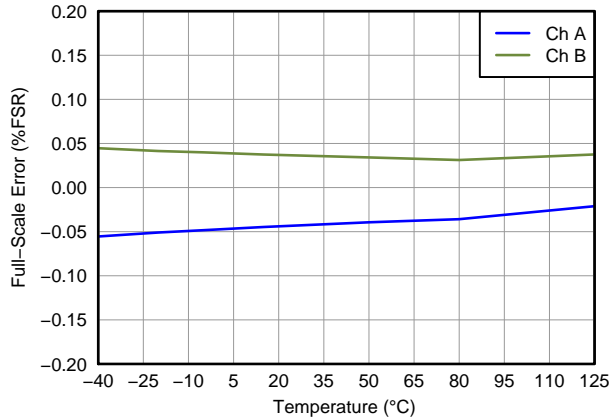

Figure 63.

**GAIN ERROR vs TEMPERATURE**

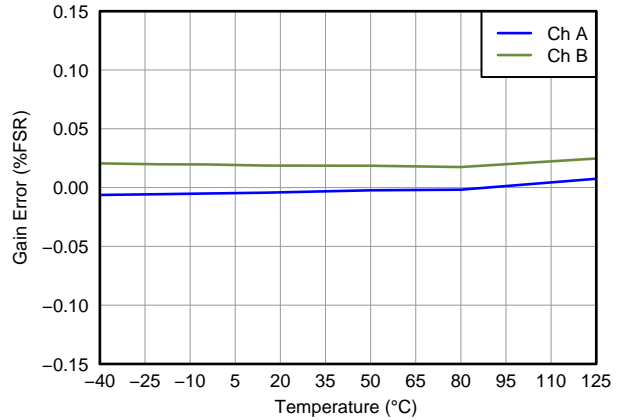

Figure 64.

**OFFSET ERROR vs TEMPERATURE**

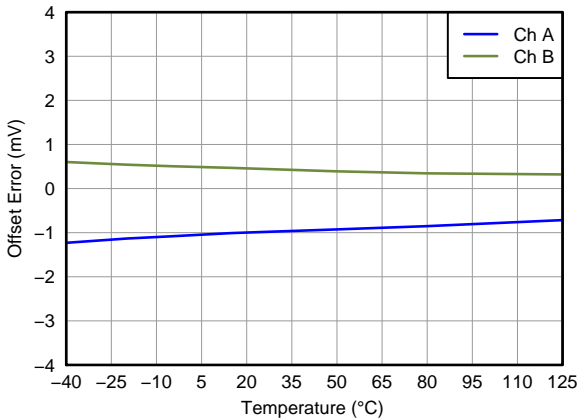

Figure 65.

**ZERO-CODE ERROR vs TEMPERATURE**

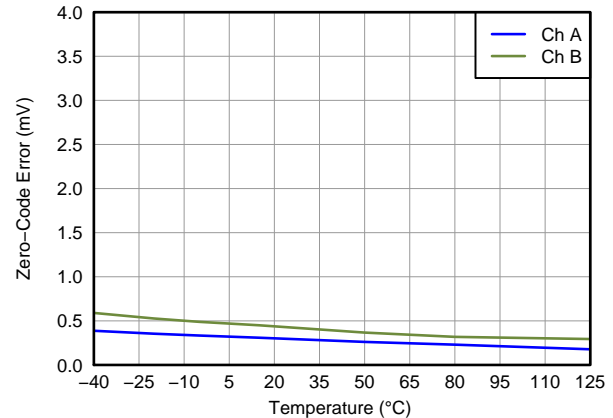
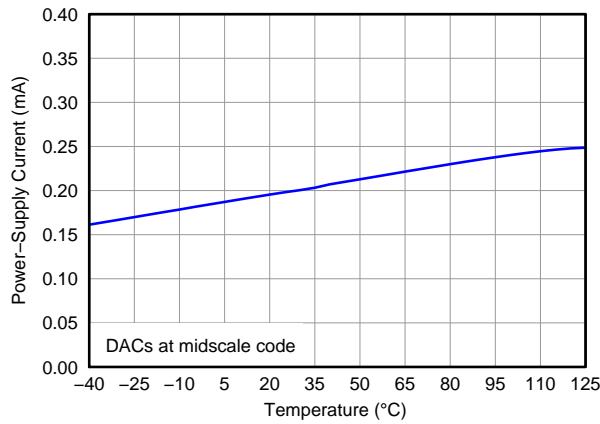

Figure 66.

**TYPICAL CHARACTERISTICS: DAC at  $V_{DD} = 2.7\text{ V}$  (continued)**

At  $T_A = 25^\circ\text{C}$ , 2.5-V external reference used, gain = 1 and DAC output not loaded, unless otherwise noted.

**POWER-SUPPLY CURRENT  
vs TEMPERATURE**



**Figure 67.**

**POWER-SUPPLY CURRENT  
vs TEMPERATURE**

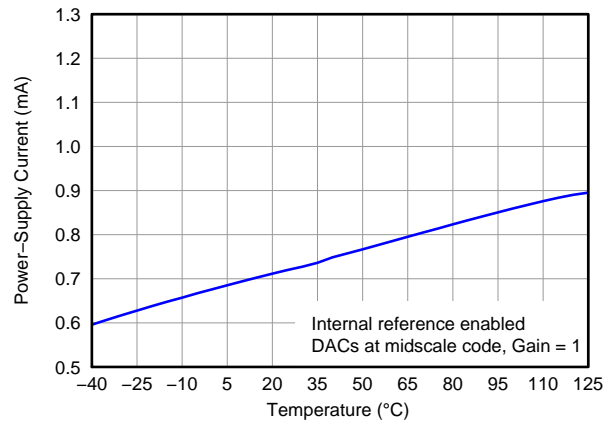

**Figure 68.**

**POWER-SUPPLY CURRENT  
vs DIGITAL INPUT CODE**

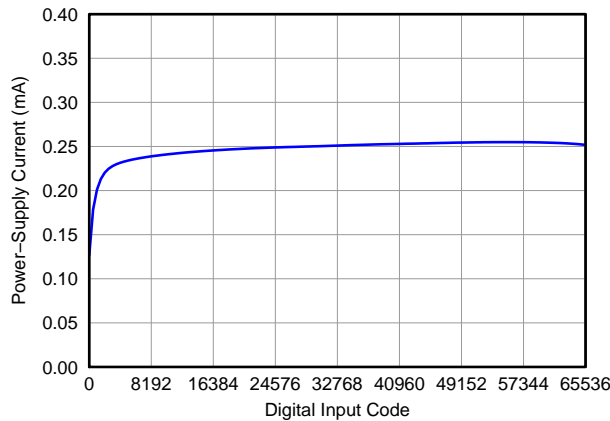

**Figure 69.**

**POWER-SUPPLY CURRENT  
vs DIGITAL INPUT CODE**

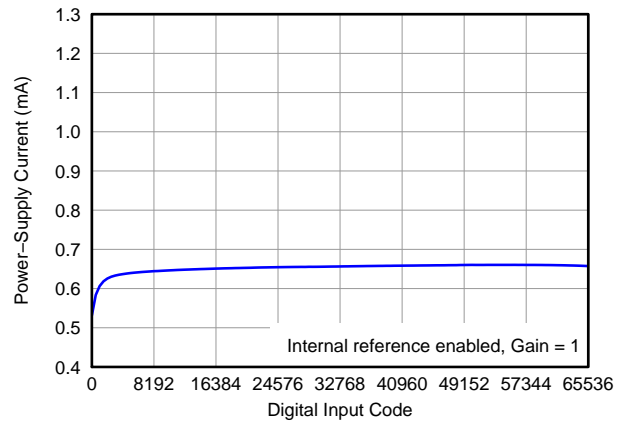

**Figure 70.**

**POWER-SUPPLY CURRENT  
HISTOGRAM**

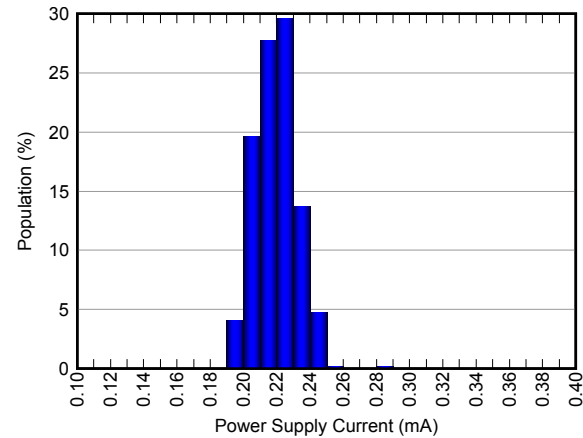

**Figure 71.**

**POWER-SUPPLY CURRENT  
HISTOGRAM**

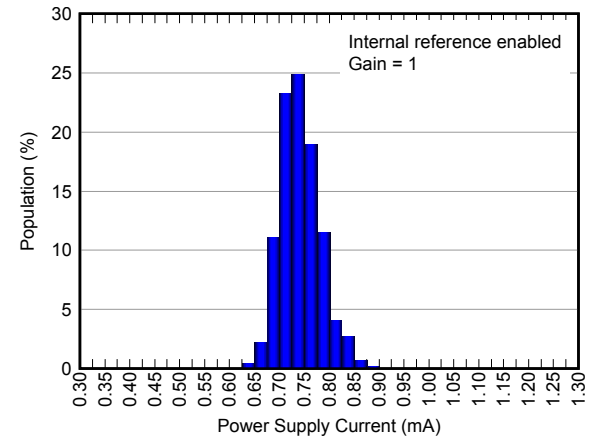
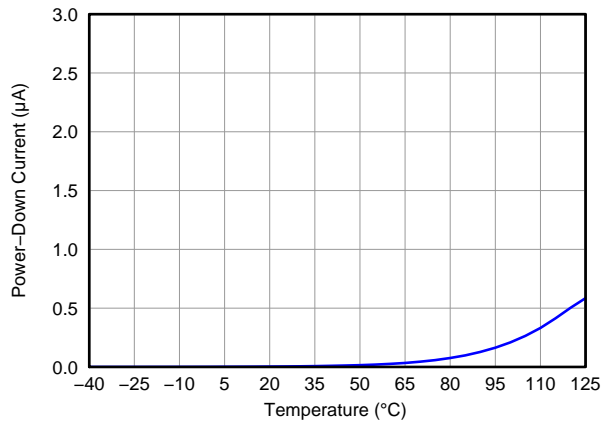

**Figure 72.**

**TYPICAL CHARACTERISTICS: DAC at  $V_{DD} = 2.7\text{ V}$  (continued)**

At  $T_A = 25^\circ\text{C}$ , 2.5-V external reference used, gain = 1 and DAC output not loaded, unless otherwise noted.

**POWER-DOWN CURRENT vs TEMPERATURE**



**Figure 73.**

**DAC OUTPUT VOLTAGE vs LOAD CURRENT**

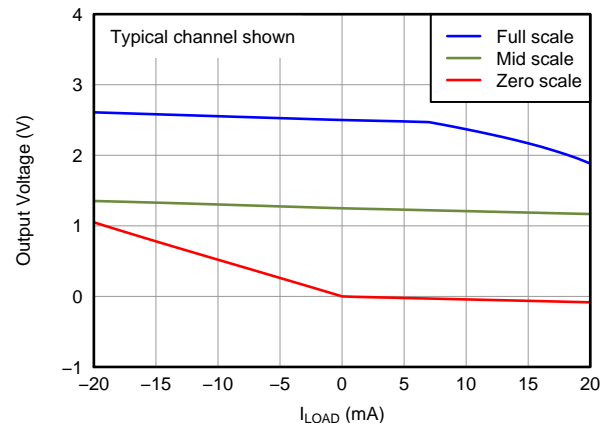

**Figure 74.**

**FULL-SCALE SETTLING TIME: RISING EDGE**

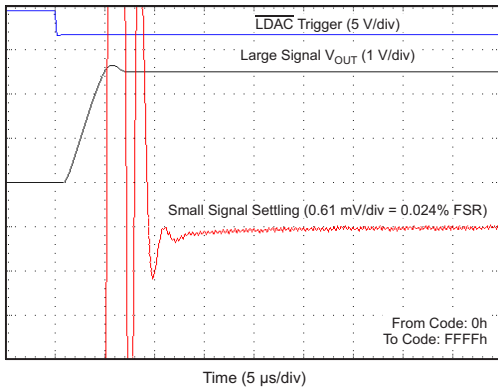

**Figure 75.**

**FULL-SCALE SETTLING TIME: FALLING EDGE**

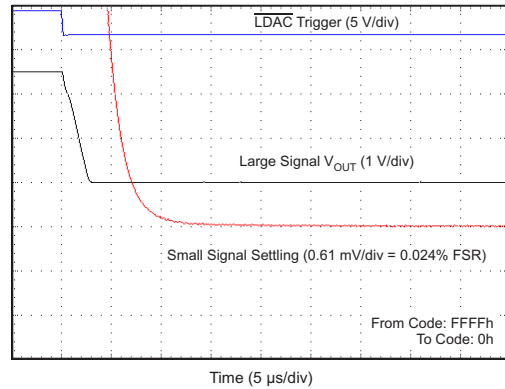

**Figure 76.**

**HALF-SCALE SETTLING TIME: RISING EDGE**

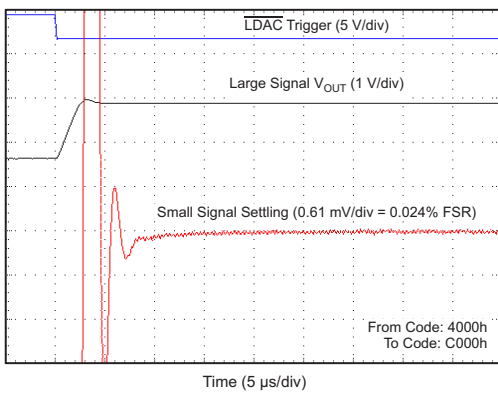

**Figure 77.**

**HALF-SCALE SETTLING TIME: FALLING EDGE**

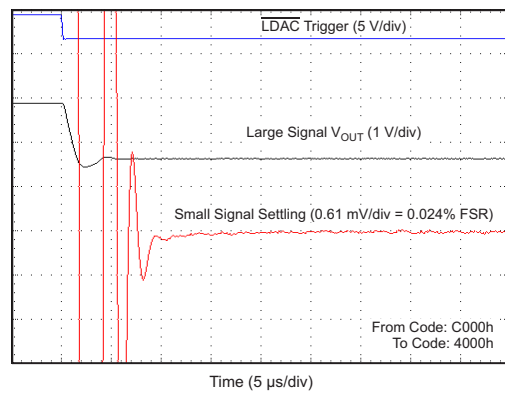
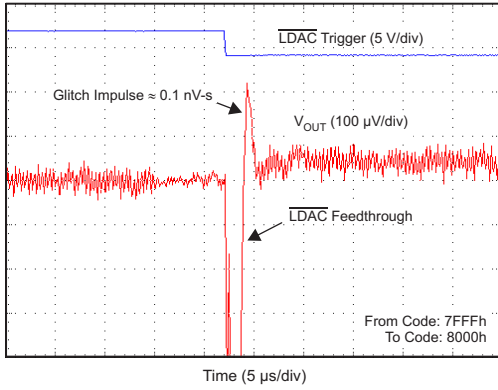

**Figure 78.**

**TYPICAL CHARACTERISTICS: DAC at  $V_{DD} = 2.7\text{ V}$  (continued)**

At  $T_A = 25^\circ\text{C}$ , 2.5-V external reference used, gain = 1 and DAC output not loaded, unless otherwise noted.

**GLITCH ENERGY  
 RISING EDGE, 1-LSB STEP**



**Figure 79.**

**GLITCH ENERGY  
 FALLING EDGE, 1-LSB STEP**

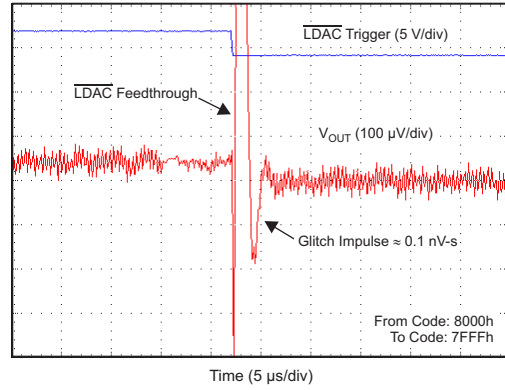

**Figure 80.**

**GLITCH ENERGY  
 RISING EDGE, 4-LSB STEP**

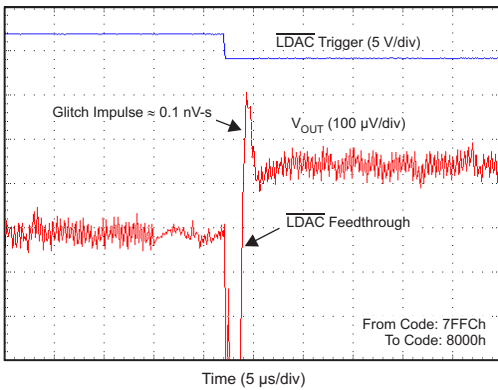

**Figure 81.**

**GLITCH ENERGY  
 FALLING EDGE, 4-LSB STEP**

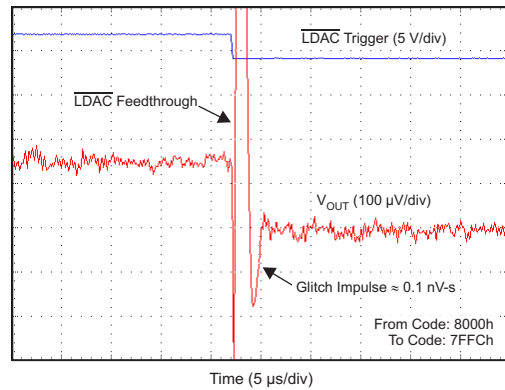

**Figure 82.**

**GLITCH ENERGY  
 RISING EDGE, 16-LSB STEP**

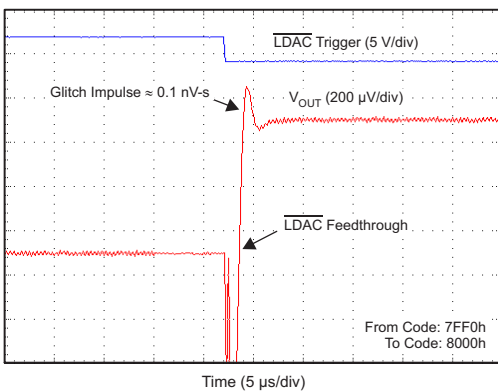

**Figure 83.**

**GLITCH ENERGY  
 FALLING EDGE, 16-LSB STEP**

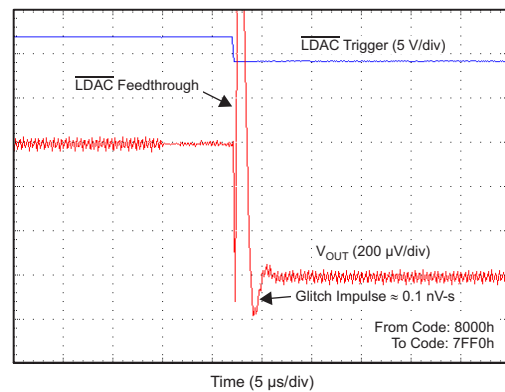

**Figure 84.**



**TYPICAL CHARACTERISTICS: DAC at  $V_{DD} = 2.7\text{ V}$  (continued)**

At  $T_A = 25^\circ\text{C}$ , 2.5-V external reference used, gain = 1 and DAC output not loaded, unless otherwise noted.

**POWER-ON GLITCH  
RESET TO ZERO SCALE**

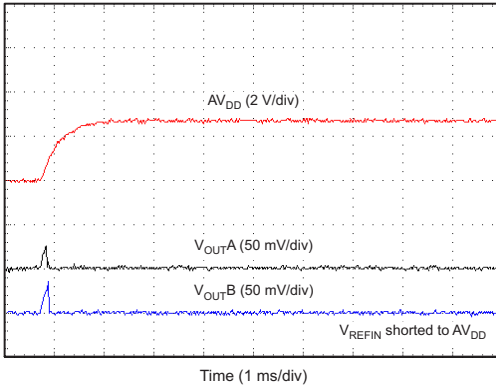

**Figure 85.**

**POWER-ON GLITCH  
RESET TO MIDSACLE**

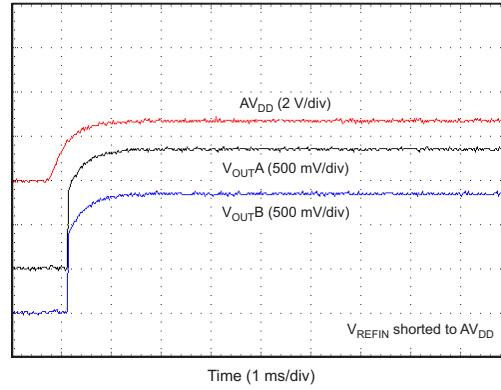

**Figure 86.**

**CLOCK FEEDTHROUGH  
500 kHz, MIDSACLE**

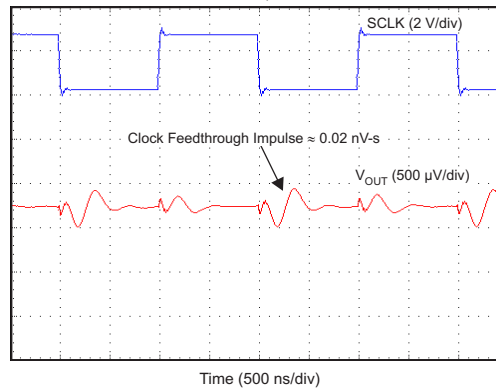

**Figure 87.**

## THEORY OF OPERATION

### DIGITAL-TO-ANALOG CONVERTER (DAC)

The DAC756x, DAC816x, and DAC856x architecture consists of two string DACs, each followed by an output buffer amplifier. The devices include an internal 2.5-V reference with 4-ppm/°C temperature drift performance. Figure 88 shows a principal block diagram of the DAC architecture.

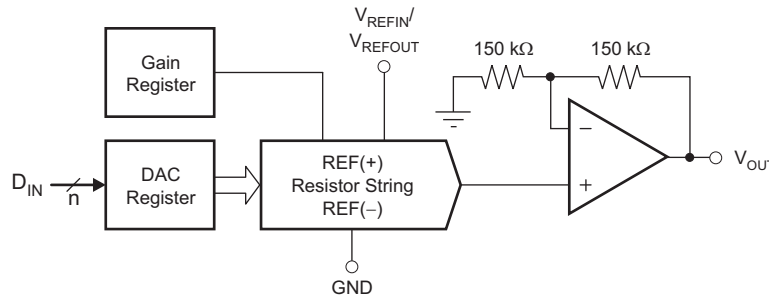

Figure 88. DAC Architecture

The input coding to the DAC756x, DAC816x, and DAC856x is straight binary, so the ideal output voltage is given by Equation 1:

$$V_{OUT} = \left( \frac{D_{IN}}{2^n} \right) \times V_{REF} \times \text{Gain} \quad (1)$$

where:

$n$  = resolution in bits; either 12 (DAC756x), 14 (DAC816x) or 16 (DAC856x)

$D_{IN}$  = decimal equivalent of the binary code that is loaded to the DAC register.  $D_{IN}$  ranges from 0 to  $2^n - 1$ .

$V_{REF}$  = DAC reference voltage; either  $V_{REFOUT}$  from the internal 2.5-V reference or  $V_{REFIN}$  from an external reference.

Gain = 1 by default when internal reference is disabled (using external reference), and gain = 2 by default when using internal reference. Gain can also be manually set to either 1 or 2 using the gain register. See the [GAIN REGISTERS](#) section for more information.

## Resistor String

The resistor string section is shown in [Figure 89](#). It is simply a string of resistors, each of value  $R$ . The code loaded into the DAC register determines at which node on the string the voltage is tapped off to be fed into the output amplifier by closing one of the switches connecting the string to the amplifier. The resistor string architecture guarantees monotonicity. The  $R_{\text{DIVIDER}}$  switch is controlled by the gain registers (see the [GAIN REGISTERS](#) section). Because the output amplifier has a gain of two,  $R_{\text{DIVIDER}}$  is not shorted when the DAC-n gain is set to one (default if internal reference is disabled), and is shorted when the DAC-n gain is set to two (default if internal reference is enabled).

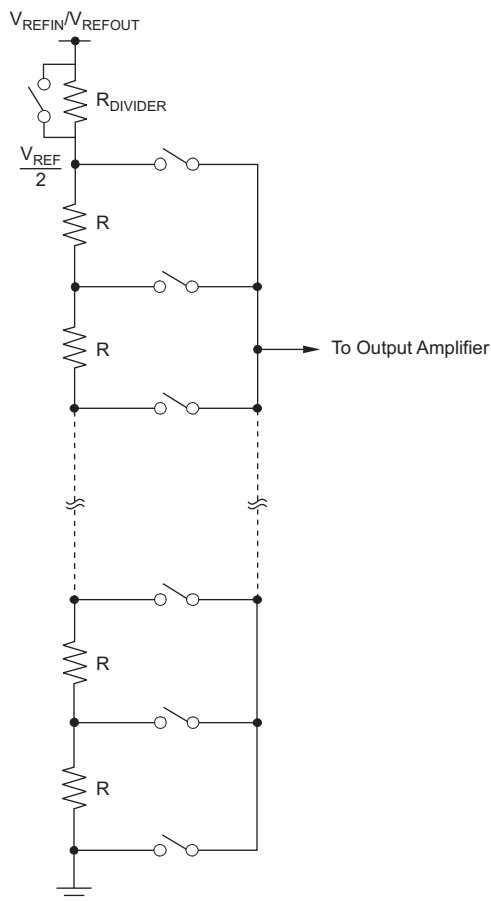

**Figure 89. Resistor String**

## Output Amplifier

The output buffer amplifier is capable of generating rail-to-rail voltages on its output, giving a maximum output range of 0 V to  $AV_{\text{DD}}$ . It is capable of driving a load of 2 k $\Omega$  in parallel with 3 nF to GND. The typical slew rate is 0.75 V/ $\mu\text{s}$ , with a typical full-scale settling time of 14  $\mu\text{s}$  as shown in [Figure 31](#), [Figure 32](#), [Figure 75](#) and [Figure 76](#).

## INTERNAL REFERENCE

The DAC756x, DAC816x, and DAC856x include a 2.5-V internal reference that is disabled by default. The internal reference is externally available at the  $V_{REFIN}/V_{REFOUT}$  pin. The internal reference output voltage is 2.5 V and can sink and source up to 20 mA.

A minimum 150-nF capacitor is recommended between the reference output and GND for noise filtering.

The internal reference of the DAC756x, DAC816x, and DAC856x is a bipolar transistor based precision bandgap voltage reference. [Figure 90](#) shows the basic bandgap topology. Transistors  $Q_1$  and  $Q_2$  are biased such that the current density of  $Q_1$  is greater than that of  $Q_2$ . The difference of the two base-emitter voltages ( $V_{BE1} - V_{BE2}$ ) has a positive temperature coefficient and is forced across resistor  $R_1$ . This voltage is amplified and added to the base-emitter voltage of  $Q_2$ , which has a negative temperature coefficient. The resulting output voltage is virtually independent of temperature. The short-circuit current is limited by design to approximately 100 mA.

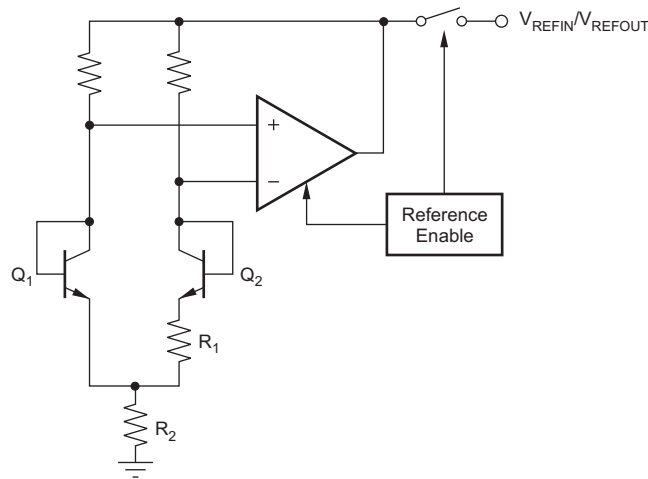

**Figure 90. Bandgap Reference Simplified Schematic**

## POWER-ON RESET

### Power-On Reset to Zero-scale

The DAC7562, DAC8162, and DAC8562 contain a power-on-reset circuit that controls the output voltage during power up. All device registers are reset as shown in [Table 6](#). At power up all DAC registers are filled with zeros and the output voltages of all DAC channels are set to zero volts. Each DAC channel remains that way until a valid load command is written to it. The power-on reset is useful in applications where it is important to know the state of the output of each DAC while the device is in the process of powering up. No device pin should be brought high before power is applied to the device. The internal reference is disabled by default and remains that way until a valid reference-change command is executed.

### Power-On Reset to Mid-scale

The DAC7563, DAC8163, and DAC8563 contain a power-on reset circuit that controls the output voltage during power up. At power up, all DAC registers are reset to mid-scale code and the output voltages of all DAC channels are set to  $V_{REFIN}/2$  volts. Each DAC channel remains that way until a valid load command is written to it. The power-on reset is useful in applications where it is important to know the state of the output of each DAC while the device is in the process of powering up. No device pin should be brought high before power is applied to the device. The internal reference is powered off/down by default and remains that way until a valid reference-change command is executed. If using an external reference, it is acceptable to power on the  $V_{REFIN}$  either at the same time as or after  $AV_{DD}$  is applied.

**Table 6. DACxx62 and DACxx63 Power-On Reset Values**

| REGISTER                    | DEFAULT SETTING                    |            |
|-----------------------------|------------------------------------|------------|
| DAC and Input registers     | DACxx62                            | Zero-scale |
|                             | DACxx63                            | Mid-scale  |
| LDAC registers              | LDAC pin enabled for both channels |            |
| Power-down registers        | DACs powered up                    |            |
| Internal reference register | Internal reference disabled        |            |
| Gain registers              | Gain = 1 for both channels         |            |

## CLR FUNCTIONALITY

The edge-triggered  $\overline{\text{CLR}}$  pin can be used to set the input and DAC registers immediately according to [Table 7](#). When the  $\overline{\text{CLR}}$  pin receives a falling edge signal the clear mode is activated and changes the DAC output voltages accordingly. The part exits clear mode on the 24<sup>th</sup> falling edge of the next write to the part. If the  $\overline{\text{CLR}}$  pin receives a falling edge signal during a write sequence in normal operation, the clear mode is activated and changes the input and DAC registers immediately according to [Table 7](#).

**Table 7. Clear Mode Reset Values**

| DEVICE                    | DAC Output Entering Clear Mode |
|---------------------------|--------------------------------|
| DAC8562, DAC8162, DAC7562 | Zero-scale                     |
| DAC8563, DAC8163, DAC7563 | Mid-scale                      |

## SERIAL INTERFACE

The DAC756x, DAC816x, and DAC856x have a 3-wire serial interface ( $\overline{\text{SYNC}}$ , SCLK, and  $D_{\text{IN}}$ ; see the [Pin Descriptions](#)) compatible with SPI, QSPI, and Microwire interface standards, as well as most DSPs. See the Serial Write Operation timing diagram ([Figure 1](#)) for an example of a typical write sequence.

The DAC756x, DAC816x, or DAC856x input shift register is 24-bits wide, consisting of two *don't care* bits (DB23 to DB22), three command bits (DB21 to DB19), three address bits (DB18 to DB16), and 16 data bits (DB15 to DB0). The 16 data bits comprise the 16-, 14-, or 12-bit input code. All 24 bits of data are loaded into the DAC under the control of the serial clock input, SCLK. DB23 (MSB) is the first bit that is loaded into the DAC shift register. It is followed by the rest of the 24-bit word pattern, left-aligned. This configuration means that the first 24 bits of data are latched into the shift register, and any further clocking of data is ignored. When the DAC registers are being written to, the DAC756x, DAC816x, and DAC856x receive all 24 bits of data, ignore DB23 and DB22, and decode the next three bits (DB21 to DB19) in order to determine the DAC operating/control mode (see [Table 8](#) through [Table 10](#)). Bits DB18 to DB16 are used to address DAC channels. The next 16/14/12 bits of data that follow are decoded by the DAC to determine the equivalent analog output. For more details on these and other commands (such as write to LDAC register, power down DACs, etc.), see their respective sections.

The data format is straight binary, with all 0s corresponding to 0-V output and all 1s corresponding to full-scale output. For all documentation purposes, the data format and representation used here is a true 16-bit pattern (that is, FFFFh data word for full scale) that the DAC756x, DAC816x, and DAC856x require.

The write sequence begins by bringing the  $\overline{\text{SYNC}}$  line low. Data from the  $D_{\text{IN}}$  line are clocked into the 24-bit shift register on each falling edge of SCLK. The serial clock frequency can be as high as 50 MHz, making the DAC756x, DAC816x, and DAC856x compatible with high-speed DSPs. On the 24<sup>th</sup> falling edge of the serial clock, the last data bit is clocked into the shift register and the shift register locks. Further clocking does not change the shift register data.

After receiving the 24<sup>th</sup> falling clock edge, the DAC756x, DAC816x, and DAC856x decode the three command bits and three address bits and 16/14/12 data bits to perform the required function, without waiting for a  $\overline{\text{SYNC}}$  rising edge. After the 24<sup>th</sup> falling edge of SCLK is received, the  $\overline{\text{SYNC}}$  line may be kept low or brought high. In either case, the minimum delay time from the 24<sup>th</sup> falling SCLK edge to the next falling  $\overline{\text{SYNC}}$  edge must be met in order to begin the next cycle properly; see the Serial Write Operation timing diagram ([Figure 1](#)).

A rising edge of  $\overline{\text{SYNC}}$  before the 24-bit sequence is complete resets the SPI interface; no data transfer occurs. A new write sequence starts at the next falling edge of  $\overline{\text{SYNC}}$ . To assure the lowest power consumption of the device, care should be taken that the levels are as close to each rail as possible.

### $\overline{\text{SYNC}}$ Interrupt

In a normal write sequence, the  $\overline{\text{SYNC}}$  line stays low for at least 24 falling edges of SCLK and the addressed DAC register updates on the 24<sup>th</sup> falling edge. However, if  $\overline{\text{SYNC}}$  is brought high before the 23<sup>rd</sup> falling edge, it acts as an interrupt to the write sequence; the shift register resets and the write sequence is discarded. Neither an update of the data buffer contents, DAC register contents, nor a change in the operating mode occurs (as shown in [Figure 91](#)).

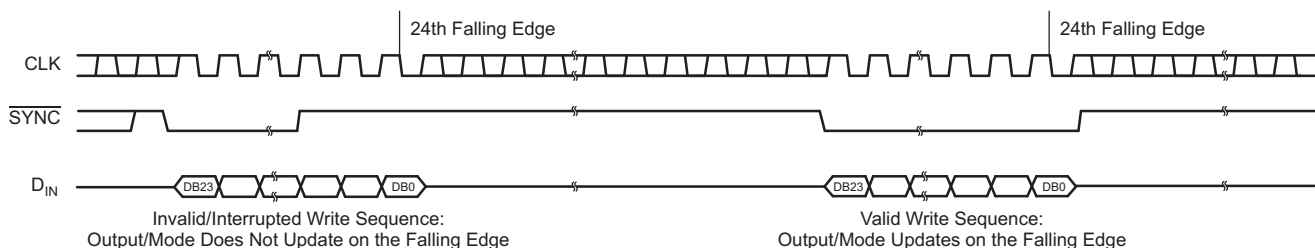

**Figure 91.  $\overline{\text{SYNC}}$  Interrupt Facility**

## Input Shift Register

The input shift register (SR) of the DAC856x, DAC816x, and DAC756x is 24 bits wide (as shown in [Table 8](#), [Table 9](#), and [Table 10](#), respectively), and consists of two *don't care* bits (DB23 to DB22), three command bits (DB21 to DB19), three address bits (DB18 to DB16), and 16 data bits (DB15 to DB0). The 16 data bits comprise the 16-, 14-, or 12-bit input code.

**Table 8. DAC856x Data Input Register Format**

|                  |   | Command |    |    | Address |    |    | Data |     |     |     |     |     |    |    |    |    |    |    |    |    |      |    |  |  |  |  |  |  |  |  |  |  |  |  |  |  |  |  |  |  |  |  |     |
|------------------|---|---------|----|----|---------|----|----|------|-----|-----|-----|-----|-----|----|----|----|----|----|----|----|----|------|----|--|--|--|--|--|--|--|--|--|--|--|--|--|--|--|--|--|--|--|--|-----|
| X <sup>(1)</sup> | X | C2      | C1 | C0 | A2      | A1 | A0 | D15  | D14 | D13 | D12 | D11 | D10 | D9 | D8 | D7 | D6 | D5 | D4 | D3 | D2 | D1   | D0 |  |  |  |  |  |  |  |  |  |  |  |  |  |  |  |  |  |  |  |  |     |
|                  |   |         |    |    |         |    |    |      |     |     |     |     |     |    |    |    |    |    |    |    |    | DB23 |    |  |  |  |  |  |  |  |  |  |  |  |  |  |  |  |  |  |  |  |  | DB0 |

(1) X denotes *don't care* bits.

**Table 9. DAC816x Data Input Register Format**

|   |   | Command |    |    | Address |    |    | Data |     |     |     |    |    |    |    |    |    |    |    |    |    |      |   |  |  |  |  |  |  |  |  |  |  |  |  |  |  |  |  |  |  |  |  |     |
|---|---|---------|----|----|---------|----|----|------|-----|-----|-----|----|----|----|----|----|----|----|----|----|----|------|---|--|--|--|--|--|--|--|--|--|--|--|--|--|--|--|--|--|--|--|--|-----|
| X | X | C2      | C1 | C0 | A2      | A1 | A0 | D13  | D12 | D11 | D10 | D9 | D8 | D7 | D6 | D5 | D4 | D3 | D2 | D1 | D0 | X    | X |  |  |  |  |  |  |  |  |  |  |  |  |  |  |  |  |  |  |  |  |     |
|   |   |         |    |    |         |    |    |      |     |     |     |    |    |    |    |    |    |    |    |    |    | DB23 |   |  |  |  |  |  |  |  |  |  |  |  |  |  |  |  |  |  |  |  |  | DB0 |

**Table 10. DAC756x Data Input Register Format**

|   |   | Command |    |    | Address |    |    | Data |     |    |    |    |    |    |    |    |    |    |    |   |   |      |   |  |  |  |  |  |  |  |  |  |  |  |  |  |  |  |  |  |  |  |  |     |
|---|---|---------|----|----|---------|----|----|------|-----|----|----|----|----|----|----|----|----|----|----|---|---|------|---|--|--|--|--|--|--|--|--|--|--|--|--|--|--|--|--|--|--|--|--|-----|
| X | X | C2      | C1 | C0 | A2      | A1 | A0 | D11  | D10 | D9 | D8 | D7 | D6 | D5 | D4 | D3 | D2 | D1 | D0 | X | X | X    | X |  |  |  |  |  |  |  |  |  |  |  |  |  |  |  |  |  |  |  |  |     |
|   |   |         |    |    |         |    |    |      |     |    |    |    |    |    |    |    |    |    |    |   |   | DB23 |   |  |  |  |  |  |  |  |  |  |  |  |  |  |  |  |  |  |  |  |  | DB0 |

The DAC856x, DAC816x, and DAC756x support a number of different load commands. The load commands are summarized in [Table 11](#) and [Table 12](#), and fully exhausted in [Table 13](#).

**Table 11. Commands for the DAC856x, DAC816x, and DAC756x**

| C2<br>(DB21) | C1<br>(DB20) | C0<br>(DB19) | Command   |
|--------------|--------------|--------------|---|
| 0            | 0            | 0            | Write to input register n ( <a href="#">Table 12</a> )                              |
| 0            | 0            | 1            | Software LDAC, update DAC register n ( <a href="#">Table 12</a> )                   |
| 0            | 1            | 0            | Write to input register n ( <a href="#">Table 12</a> ) and update all DAC registers |
| 0            | 1            | 1            | Write to input register n and update DAC register n ( <a href="#">Table 12</a> )    |
| 1            | 0            | 0            | Set DAC power up/down mode  |
| 1            | 0            | 1            | Software reset  |
| 1            | 1            | 0            | Set LDAC registers  |
| 1            | 1            | 1            | Enable/disable internal reference   |

**Table 12. Address Select for the DAC856x, DAC816x, and DAC756x**

| A2<br>(DB18) | A1<br>(DB17) | A0<br>(DB16) | Channel (n)                      |
|--------------|--------------|--------------|----------------------------------|
| 0            | 0            | 0            | DAC-A                            |
| 0            | 0            | 1            | DAC-B                            |
| 0            | 1            | 0            | Gain (only use with command 000) |
| 0            | 1            | 1            | Reserved                         |
| 1            | 0            | 0            | Reserved                         |
| 1            | 0            | 1            | Reserved                         |
| 1            | 1            | 0            | Reserved                         |
| 1            | 1            | 1            | DAC-A and DAC-B                  |

**Table 13. Command Matrix for the DAC856x, DAC816x, and DAC756x**

| DB23-DB22        | Command |    |    | Address |    |    | Data                  |     |     |         |     |   | DESCRIPTION   |   |  |
|------------------|---------|----|----|---------|----|----|-----------------------|-----|-----|---------|-----|---|---|---|--|
|                  | C2      | C1 | C0 | A2      | A1 | A0 | DB15-DB6              | DB5 | DB4 | DB3-DB2 | DB1 | DB0   |   |   |  |
| X <sup>(1)</sup> | 0       | 0  | 0  | 0       | 0  | 0  | 16/14/12 bit DAC data |     |     |         |     |   | Write to DAC-A input register                               |   |  |
|                  |         |    |    | 0       | 0  | 1  | 16/14/12 bit DAC data |     |     |         |     |   | Write to DAC-B input register                               |   |  |
|                  |         |    |    | 1       | 1  | 1  | 16/14/12 bit DAC data |     |     |         |     |   | Write to DAC-A and DAC-B input registers                    |   |  |
| X                | 0       | 1  | 0  | 0       | 0  | 0  | 16/14/12 bit DAC data |     |     |         |     |   | Write to DAC-A input register and update all DACs           |   |  |
|                  |         |    |    | 0       | 0  | 1  | 16/14/12 bit DAC data |     |     |         |     |   | Write to DAC-B input register and update all DACs           |   |  |
|                  |         |    |    | 1       | 1  | 1  | 16/14/12 bit DAC data |     |     |         |     |   | Write to DAC-A and DAC-B input register and update all DACs |   |  |
| X                | 0       | 1  | 1  | 0       | 0  | 0  | 16/14/12 bit DAC data |     |     |         |     |   | Write to DAC-A input register and update DAC-A              |   |  |
|                  |         |    |    | 0       | 0  | 1  | 16/14/12 bit DAC data |     |     |         |     |   | Write to DAC-B input register and update DAC-B              |   |  |
|                  |         |    |    | 1       | 1  | 1  | 16/14/12 bit DAC data |     |     |         |     |   | Write to DAC-A and DAC-B input register and update all DACs |   |  |
| X                | 0       | 0  | 1  | 0       | 0  | 0  | X                     |     |     |         |     |   | Update DAC-A  |   |  |
|                  |         |    |    | 0       | 0  | 1  | X                     |     |     |         |     |   | Update DAC-B  |   |  |
|                  |         |    |    | 1       | 1  | 1  | X                     |     |     |         |     |   | Update all DACs   |   |  |
| X                | 0       | 0  | 0  | 0       | 1  | 0  | X                     |     |     |         |     |   | 0   | 0 | Gain: DAC-B gain = 2, DAC-A gain = 2 (default with internal V <sub>REF</sub> ) |
|                  |         |    |    |         |    |    |                       |     |     |         |     |   | 0   | 1 | Gain: DAC-B gain = 2, DAC-A gain = 1   |
|                  |         |    |    |         |    |    |                       |     |     |         |     |   | 1   | 0 | Gain: DAC-B gain = 1, DAC-A gain = 2   |
|                  |         |    |    |         |    |    |                       |     |     |         |     |   | 1   | 1 | Gain: DAC-B gain = 1, DAC-A gain = 1 (power-on default)                        |
| X                | 1       | 0  | 0  | X       |    |    | X                     | 0   | 0   | X       | 0   | 1   | Power up DAC-A  |   |  |
|                  |         |    |    |         |    |    |                       |     |     |         | 1   | 0   | Power up DAC-B  |   |  |
|                  |         |    |    |         |    |    |                       |     |     |         | 1   | 1   | Power up DAC-A and DAC-B                                    |   |  |
| X                | 1       | 0  | 0  | X       |    |    | X                     | 0   | 1   | X       | 0   | 1   | Power down DAC-A; 1 kΩ to GND                               |   |  |
|                  |         |    |    |         |    |    |                       |     |     |         | 1   | 0   | Power down DAC-B; 1 kΩ to GND                               |   |  |
|                  |         |    |    |         |    |    |                       |     |     |         | 1   | 1   | Power down DAC-A and DAC-B; 1 kΩ to GND                     |   |  |
| X                | 1       | 0  | 0  | X       |    |    | X                     | 1   | 0   | X       | 0   | 1   | Power down DAC-A; 100 kΩ to GND                             |   |  |
|                  |         |    |    |         |    |    |                       |     |     |         | 1   | 0   | Power down DAC-B; 100 kΩ to GND                             |   |  |
|                  |         |    |    |         |    |    |                       |     |     |         | 1   | 1   | Power down DAC-A and DAC-B; 100 kΩ to GND                   |   |  |
| X                | 1       | 0  | 0  | X       |    |    | X                     | 1   | 1   | X       | 0   | 1   | Power down DAC-A; Hi-Z                                      |   |  |
|                  |         |    |    |         |    |    |                       |     |     |         | 1   | 0   | Power down DAC-B; Hi-Z                                      |   |  |
|                  |         |    |    |         |    |    |                       |     |     |         | 1   | 1   | Power down DAC-A and DAC-B; Hi-Z                            |   |  |
| X                | 1       | 0  | 1  | X       |    |    | X                     |     |     | X       | 0   | Reset DAC-A and DAC-B input register and update all DACs          |   |   |  |
|                  |         |    |    |         |    |    |                       |     |     | X       | 1   | Reset all registers and update all DACs (Power-on-reset update)   |   |   |  |
| X                | 1       | 1  | 0  | X       |    |    | X                     |     |     | 0       | 0   | $\overline{\text{LDAC}}$ pin active for DAC-B and DAC-A           |   |   |  |
|                  |         |    |    |         |    |    |                       |     |     | 0       | 1   | $\overline{\text{LDAC}}$ pin active for DAC-B; inactive for DAC-A |   |   |  |
|                  |         |    |    |         |    |    |                       |     |     | 1       | 0   | $\overline{\text{LDAC}}$ pin inactive for DAC-B; active for DAC-A |   |   |  |
|                  |         |    |    |         |    |    |                       |     |     | 1       | 1   | $\overline{\text{LDAC}}$ pin inactive for DAC-B and DAC-A         |   |   |  |
| X                | 1       | 1  | 1  | X       |    |    | X                     |     |     | X       | 0   | Disable internal reference and reset DACs to gain = 1             |   |   |  |
|                  |         |    |    |         |    |    |                       |     |     | X       | 1   | Enable Internal Reference & reset DACs to gain = 2                |   |   |  |

(1) X denotes *don't care* bits.



## GAIN REGISTERS

The gain register controls the GAIN setting in the DAC transfer function:

$$V_{OUT} = \left( \frac{D_{IN}}{2^n} \right) \times V_{REF} \times \text{Gain} \quad (2)$$

The DAC756x, DAC816x, and DAC856x have a gain register for each channel. The gain for each channel, in [Equation 2](#), is either 1 or 2. This gain is automatically set to 2 when using the internal reference, and is automatically set to 1 when the internal reference is disabled (default). However, each channel can have either gain by setting the registers appropriately. The gain registers are accessible by using command bits = 000 and address bits = 010, and using DB1 for DAC-B and DB0 for DAC-A. See [Table 13](#) or [Table 14](#) and [Table 15](#) for the full command structure. The gain registers are automatically reset to provide either gain of 1 or 2 when the internal reference is powered off or on, respectively. After the reference is powered off or on, the gain register is again accessible to change the gain.

**Table 14. Gain Register Command Structure**

|      |   | Command |   |   | Address |   |   | Data |   |   |   |   |   |   |   |   |   |   |   |   |   | DAC-B | DAC-A |   |   |  |  |
|------|---|---------|---|---|---------|---|---|------|---|---|---|---|---|---|---|---|---|---|---|---|---|-------|-------|---|---|--|--|
| X    | X | 0       | 0 | 0 | 0       | 1 | 0 | X    | X | X | X | X | X | X | X | X | X | X | X | X | X | X     | X     | X | X |  |  |
| DB23 |   |         |   |   |         |   |   |      |   |   |   |   |   |   |   |   |   |   |   |   |   |       | DB0   |   |   |  |  |

**Table 15. DAC-n Selection for Gain Register Command**

| DB1/DB0 | Value | Gain  |
|---------|-------|---|
| DB0     | 0     | DAC-A uses gain = 2 (default with internal reference) |
|         | 1     | DAC-A uses gain = 1 (default with external reference) |
| DB1     | 0     | DAC-B uses gain = 2 (default with internal reference) |
|         | 1     | DAC-B uses gain = 1 (default with external reference) |

## POWER-DOWN MODES

The DAC756x, DAC816x, and DAC856x have two separate sets of power-down commands. One set is for the DAC channels and the other set is for the internal reference. The internal reference is forced to a powered down state while both DAC channels are powered down, and is only enabled if any DAC channel is also in normal mode of operation. For more information on the internal reference control, see the [INTERNAL REFERENCE ENABLE REGISTER](#) section.

### DAC Power-Down Commands

The DAC756x, DAC816x, and DAC856x DACs use four modes of operation. These modes are accessed by setting command bits C2, C1, and C0, and power-down register bits DB5 and DB4. The command bits must be set to 100. Once the command bits are set correctly, the four different power down modes are software programmable by setting bits DB5 and DB4 in the shift register. [Table 13](#) or [Table 16](#) through [Table 18](#) shows how to control the operating mode with data bits PD1 (DB5), PD0 (DB4), DB1, and DB0.

**Table 16. DAC Power Mode Register Command Structure**

| Command |   |   | Address |   |   | Data |   |   |   |     |   |   |   |   |   |   |   |   |   |   |     |     |   |   |       |       |
|---------|---|---|---------|---|---|------|---|---|---|-----|---|---|---|---|---|---|---|---|---|---|-----|-----|---|---|-------|-------|
| X       | X | 1 | 0       | 0 | X | X    | X | X | X | X   | X | X | X | X | X | X | X | X | X | X | PD1 | PD0 | X | X | DAC-B | DAC-A |
| DB23    |   |   |         |   |   |      |   |   |   | DB0 |   |   |   |   |   |   |   |   |   |   |     |     |   |   |       |       |

**Table 17. DAC-n Operating Modes**

| PD1 (DB5) | PD0 (DB4) | DAC OPERATING MODES                           |
|-----------|-----------|---|
| 0         | 0         | Power up selected DACs (normal mode, default) |
| 0         | 1         | Power down selected DACs 1 kΩ to GND          |
| 1         | 0         | Power down selected DACs 100 kΩ to GND        |
| 1         | 1         | Power down selected DACs Hi-Z to GND          |

**Table 18. DAC-n Selection for Operating Modes**

| DB1/DB0 | Operating Mode                                   |
|---------|--|
| 0       | DAC-n does not change operating mode             |
| 1       | DAC-n operating mode set to value on PD1 and PD0 |

It is possible to write to the DAC register/buffer of the DAC channel that is powered down. When the DAC channel is then powered up, it powers up to this new value.

The advantage of the available power-down modes is that the output impedance of the device is known while it is in power-down mode. As described in [Table 17](#), there are three different power-down options.  $V_{OUT}$  can be connected internally to GND through a 1-kΩ resistor, a 100-kΩ resistor, or open-circuited (Hi-Z). The DAC powerdown circuitry is shown in [Figure 92](#).

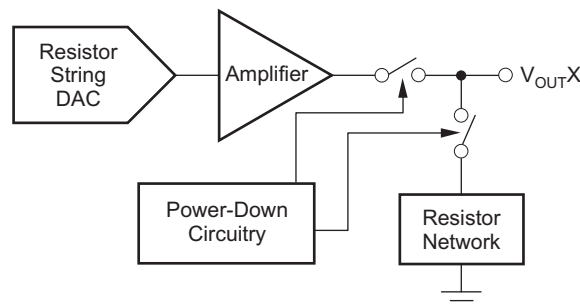

**Figure 92. Output Stage**



Alternatively, all DAC outputs can be updated simultaneously using the built-in software function of LDAC. The LDAC register offers additional flexibility and control by allowing the selection of which DAC channel(s) should be updated simultaneously when the LDAC pin is being brought low. The LDAC register is loaded with a 2-bit word (DB1 and DB0) using command bits C2, C1, and C0 (see [Table 13](#) or [Table 21](#)). The default value for each bit, and therefore for each DAC channel, is zero. If the LDAC register bit is set to 1, it overrides the LDAC pin (the LDAC pin is internally tied low for that particular DAC channel) and this DAC channel updates synchronously after the falling edge of the 24<sup>th</sup> SCLK cycle. However, if the LDAC register bit is set to 0, the DAC channel is controlled by the LDAC pin.

The combination of software and hardware simultaneous update functions is particularly useful in applications when updating a DAC channel, while keeping the other channel unaffected; see [Table 13](#) or [Table 21](#) and [Table 22](#) for more information.

**Table 21. LDAC Register Command Structure**

|      |   | Command |   |   | Address |   |   | Data |   |   |   |   |   |   |   |   |   |   |   |   |   | DAC-B | DAC-A |   |   |   |     |   |   |  |  |  |  |  |  |  |  |  |  |  |  |  |  |  |  |  |  |  |  |  |  |  |  |
|------|---|---------|---|---|---------|---|---|------|---|---|---|---|---|---|---|---|---|---|---|---|---|-------|-------|---|---|---|-----|---|---|--|--|--|--|--|--|--|--|--|--|--|--|--|--|--|--|--|--|--|--|--|--|--|--|
| X    | X | 1       | 1 | 0 | X       | X | X | X    | X | X | X | X | X | X | X | X | X | X | X | X | X | X     | X     | X | X | X | X   | X | X |  |  |  |  |  |  |  |  |  |  |  |  |  |  |  |  |  |  |  |  |  |  |  |  |
| DB23 |   |         |   |   |         |   |   |      |   |   |   |   |   |   |   |   |   |   |   |   |   |       |       |   |   |   | DB0 |   |   |  |  |  |  |  |  |  |  |  |  |  |  |  |  |  |  |  |  |  |  |  |  |  |  |

**Table 22. DAC-n Selection for LDAC Register Command**

| DB1/DB0 | Value | LDAC Pin Functionality             |
|---------|-------|------------------------------------|
| DB0     | 0     | DAC-A uses LDAC pin                |
|         | 1     | DAC-A operates in synchronous mode |
| DB1     | 0     | DAC-B uses LDAC pin                |
|         | 1     | DAC-B operates in synchronous mode |

## INTERNAL REFERENCE ENABLE REGISTER

The internal reference in the DAC756x, DAC816x, and DAC856x is disabled by default for debugging, evaluation purposes, or when using an external reference. The internal reference can be powered up and powered down using a serial command that requires a 24-bit write sequence, as shown in [Table 23](#) and [Table 24](#). The internal reference is forced to a powered down state while both DAC channels are powered down, and is only enabled if any DAC channel is in normal mode of operation in addition to using the command in [Table 23](#). During the time that the internal reference is disabled, the DAC functions normally using an external reference. At this point, the internal reference is disconnected from the V<sub>REFIN</sub>/V<sub>REFOUT</sub> pin (Hi-Z output).

### Enabling Internal Reference

To enable the internal reference, write the 24-bit serial command shown in [Table 23](#). When performing a power cycle to reset the device, the internal reference is switched off (default mode). In the default mode, the internal reference is powered down until a valid write sequence is applied to power up the internal reference. However, the internal reference is forced to a disabled state while both DAC channels are powered down, and remains disabled until either DAC channel is returned to the normal mode of operation. See [DAC Power-Down Commands](#) for more information on DAC channel modes of operation.

**Table 23. Write Sequence for Enabling Internal Reference**

|      |   | Command |   |   | Address |   |   | Data |   |   |   |   |   |   |   |   |   |   |   |   |   |   |   |   |   |   |     |   |   |  |   |  |  |  |  |  |  |  |  |  |  |  |  |  |  |  |  |  |  |  |  |  |  |
|------|---|---------|---|---|---------|---|---|------|---|---|---|---|---|---|---|---|---|---|---|---|---|---|---|---|---|---|-----|---|---|--|---|--|--|--|--|--|--|--|--|--|--|--|--|--|--|--|--|--|--|--|--|--|--|
| X    | X | 1       | 1 | 1 | X       | X | X | X    | X | X | X | X | X | X | X | X | X | X | X | X | X | X | X | X | X | X | X   | X | X |  | 1 |  |  |  |  |  |  |  |  |  |  |  |  |  |  |  |  |  |  |  |  |  |  |
| DB23 |   |         |   |   |         |   |   |      |   |   |   |   |   |   |   |   |   |   |   |   |   |   |   |   |   |   | DB0 |   |   |  |   |  |  |  |  |  |  |  |  |  |  |  |  |  |  |  |  |  |  |  |  |  |  |

### Disabling Internal Reference

To disable the internal reference, write the 24-bit serial command shown in [Table 24](#). When performing a power cycle to reset the device, the internal reference is disabled (default mode).

**Table 24. Write Sequence for Disabling Internal Reference**

|      |   | Command |   |   | Address |   |   | Data |   |   |   |   |   |   |   |   |   |   |   |   |   |   |   |   |   |   |     |   |   |   |  |   |  |  |  |  |  |  |  |  |  |  |  |  |  |  |  |  |  |  |  |  |  |
|------|---|---------|---|---|---------|---|---|------|---|---|---|---|---|---|---|---|---|---|---|---|---|---|---|---|---|---|-----|---|---|---|--|---|--|--|--|--|--|--|--|--|--|--|--|--|--|--|--|--|--|--|--|--|--|
| X    | X | 1       | 1 | 1 | X       | X | X | X    | X | X | X | X | X | X | X | X | X | X | X | X | X | X | X | X | X | X | X   | X | X | X |  | 0 |  |  |  |  |  |  |  |  |  |  |  |  |  |  |  |  |  |  |  |  |  |
| DB23 |   |         |   |   |         |   |   |      |   |   |   |   |   |   |   |   |   |   |   |   |   |   |   |   |   |   | DB0 |   |   |   |  |   |  |  |  |  |  |  |  |  |  |  |  |  |  |  |  |  |  |  |  |  |  |

## APPLICATION INFORMATION

### INTERNAL REFERENCE

The internal reference of the DAC756x, DAC816x, and DAC856x does not require an external load capacitor for stability because it is stable without any capacitive load. However, for improved noise performance, an external load capacitor of 150 nF or larger connected to the  $V_{REFIN}/V_{REFOUT}$  output is recommended. Figure 93 shows the typical connections required for operation of the DAC756x, DAC816x, and DAC856x internal reference. A supply bypass capacitor at the  $AV_{DD}$  input is also recommended.

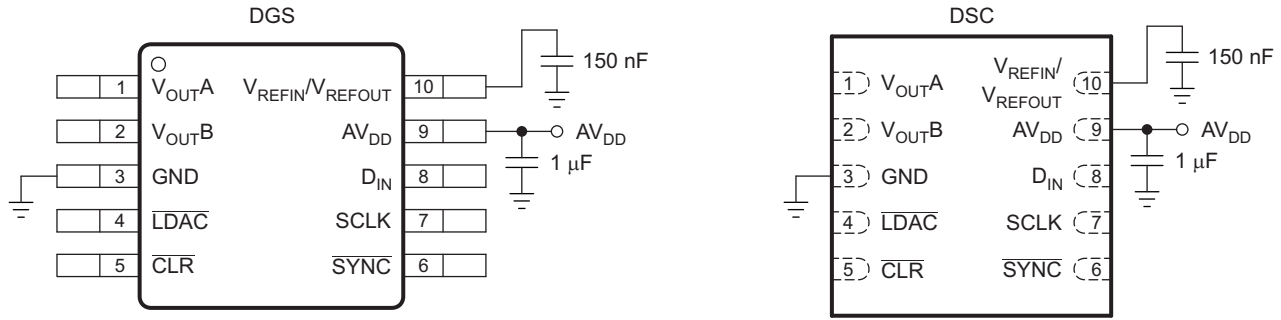

**Figure 93. Typical Connections for Operating the DAC756x/DAC816x/DAC856x Internal Reference**

### Supply Voltage

The internal reference features an extremely low dropout voltage. It can be operated with a supply of only 5 mV above the reference output voltage in an unloaded condition. For loaded conditions, refer to the *Load Regulation* section. The stability of the internal reference with variations in supply voltage (line regulation, DC PSRR) is also exceptional. Within the specified supply voltage range of 2.7 V to 5.5 V, the variation at  $V_{REFIN}/V_{REFOUT}$  is typically 50  $\mu\text{V}/\text{V}$ ; see Figure 7.

### Temperature Drift

The internal reference is designed to exhibit minimal drift error, defined as the change in reference output voltage over varying temperature. The drift is calculated using the box method described by Equation 3:

$$\text{Drift Error} = \left( \frac{V_{REF\_MAX} - V_{REF\_MIN}}{V_{REF} \times T_{RANGE}} \right) \times 10^6 \text{ (ppm}/^\circ\text{C)} \quad (3)$$

where:

$V_{REF\_MAX}$  = maximum reference voltage observed within temperature range  $T_{RANGE}$ .

$V_{REF\_MIN}$  = minimum reference voltage observed within temperature range  $T_{RANGE}$ .

$V_{REF}$  = 2.5 V, target value for reference output voltage.

$T_{RANGE}$  = the characterized range from  $-40^\circ\text{C}$  to  $125^\circ\text{C}$  (165 $^\circ\text{C}$  range)

The internal reference features an exceptional typical drift coefficient of 4 ppm/ $^\circ\text{C}$  from  $-40^\circ\text{C}$  to  $125^\circ\text{C}$ . Characterizing a large number of units, a maximum drift coefficient of 10 ppm/ $^\circ\text{C}$  is observed. Temperature drift results are summarized in Figure 3.

### Noise Performance

Typical 0.1-Hz to 10-Hz voltage noise and noise spectral density performance are listed in the *Electrical Characteristics*. Additional filtering can be used to improve output noise levels, although care should be taken to ensure the output impedance does not degrade the AC performance. The output noise spectrum at the  $V_{REFIN}/V_{REFOUT}$  pin, both unloaded and with an external 4.7- $\mu\text{F}$  load capacitor, is shown in Figure 6. Internal reference noise impacts the DAC output noise when the internal reference is used.

## Load Regulation

Load regulation is defined as the change in reference output voltage as a result of changes in load current. The load regulation of the internal reference is measured using force and sense contacts as shown in [Figure 94](#). The force and sense lines reduce the impact of contact and trace resistance, resulting in accurate measurement of the load regulation contributed solely by the internal reference. Measurement results are shown in [Figure 4](#). Force and sense lines should be used for applications that require improved load regulation.

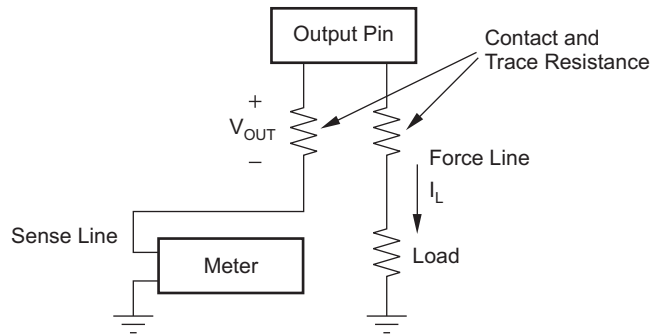

**Figure 94. Accurate Load Regulation of the DAC756x/DAC816x/DAC856x Internal Reference**

## Long-Term Stability

Long-term stability/aging refers to the change of the output voltage of a reference over a period of months or years. This effect lessens as time progresses. The typical drift value for the internal reference is listed in the *Electrical Characteristics* and measurement results are shown in [Figure 5](#). This parameter is characterized by powering up multiple devices and measuring them at regular intervals.

## Thermal Hysteresis

Thermal hysteresis for a reference is defined as the change in output voltage after operating the device at 25°C, cycling the device through the operating temperature range, and returning to 25°C. Hysteresis is expressed by [Equation 4](#):

$$V_{\text{HYST}} = \left[ \frac{V_{\text{REF\_PRE}} - V_{\text{REF\_POST}}}{V_{\text{REF\_NOM}}} \right] \times 10^6 (\text{ppm}/^\circ\text{C}) \quad (4)$$

Where:

$V_{\text{HYST}}$  = thermal hysteresis.

$V_{\text{REF\_PRE}}$  = output voltage measured at 25°C pre-temperature cycling.

$V_{\text{REF\_POST}}$  = output voltage measured after the device cycles through the temperature range of –40°C to 125°C, and returns to 25°C.

$V_{\text{REF\_NOM}}$  = 2.5 V, target value for reference output voltage.

## DAC NOISE PERFORMANCE

Output noise spectral density at the  $V_{\text{OUT-n}}$  pin versus frequency is depicted in [Figure 45](#) and [Figure 46](#) for full-scale, mid-scale, and zero-scale input codes. The typical noise density for mid-scale code is 90 nV/ $\sqrt{\text{Hz}}$  at 1 kHz. High-frequency noise can be improved by filtering the reference noise. Integrated output noise between 0.1 Hz and 10 Hz is close to 2.5  $\mu\text{V}_{\text{PP}}$  (mid-scale), as shown in [Figure 47](#).

## UP TO ±15-V BIPOLAR OUTPUT USING THE DAC8562

The DAC8562 is designed to be operate from a single power supply providing a maximum output range of  $V_{DD}$  volts. However, the DAC can be placed in the configuration shown in [Figure 95](#) in order to be designed into bipolar systems. Depending on the ratio of the resistor values, the output of the circuit can range anywhere from  $\pm 5$  V to  $\pm 15$  V. The design example below shows that the DAC is configured to have its internal reference enabled and the DAC8562 internal gain set to two, however, an external 2.5-V reference could also be used (with DAC8562 internal gain set to two).

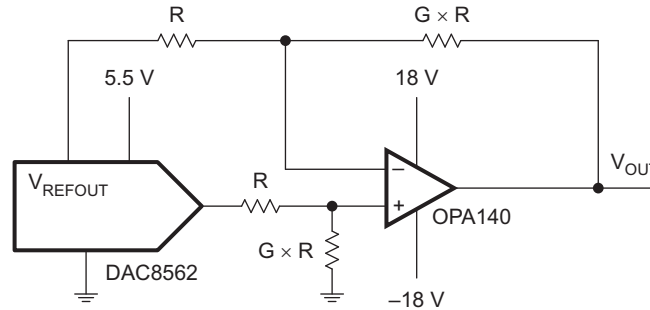

**Figure 95. Bipolar Output Range Circuit Using DAC8562**

The transfer function shown in [Equation 5](#) can be used to calculate the output voltage as a function of the DAC code, reference voltage and resistor ratio:

$$V_{OUT} = G \times V_{REFOUT} \left( 2 \times \frac{D_{IN}}{65,536} - 1 \right) \quad (5)$$

where:

$D_{IN}$  = decimal equivalent of the binary code that is loaded to the DAC register, ranging from 0 to 65,535 for DAC8562 (16 bit).

$V_{REFOUT}$  = reference output voltage with the internal reference enabled from the DAC  $V_{REFIN}/V_{REFOUT}$  pin

$G$  = ratio of the resistors

An example configuration to generate a  $\pm 10$ -V output range is shown below in [Equation 6](#) with  $G = 4$  and  $V_{REFOUT} = 2.5$  V:

$$V_{OUT} = 20 \times \frac{D_{IN}}{65,536} - 10 \text{ V} \quad (6)$$

In this example, the range is set to  $\pm 10$  V by using a resistor ratio of four,  $V_{REFOUT}$  of 2.5 V, and DAC8562 internal gain of two. The resistor sizes must be selected keeping in mind the current sink/source capability of the DAC8562 internal reference. Using larger resistor values, for example  $R = 10$  k $\Omega$  or larger is recommended. The op amp is selectable depending on the requirements of the system.

The DAC8562EVM and DAC7562EVM boards have the option to evaluate the bipolar output application by installing the components on the pre-placed footprints. For more information see either the [DAC8562EVM](#) or [DAC7562EVM](#) product folder.

## PLC ANALOG OUTPUT MODULE USING THE DAC8562

The DAC8562 can be mated with one of TI's 0- to 20-mA voltage-to-current transmitters to create a low-cost, programmable current source for use in PLC applications. One specific example includes combining the DAC8562 with the XTR111 to create a voltage-to-current solution. The DAC output voltage generates a current,  $I_{SET}$ , which is determined by the value of the external resistor,  $R_{SET}$ . This current is internally amplified by 10 and output at the IS node. A p-channel MOSFET Q1 can be added in an application where a wide compliance voltage is required, for example, when using a high impedance load. The optional PNP transistor, Q2, along with the R4 resistor provides external current limiting in a case where the external FET is forced to low impedance. Additionally, resistors R2 and R3 can be used to scale the 3-V internal regulator to a desired voltage to power the DAC. Figure 96 shows a working 0- to 20-mA solution using one DAC8562 channel and a  $\pm 10$ -V voltage output using the other DAC8562 channel. For more information on the  $\pm 10$ -V voltage output circuit see the [UP TO  \$\pm 15\$ -V BIPOLAR OUTPUT USING THE DAC8562](#) application.

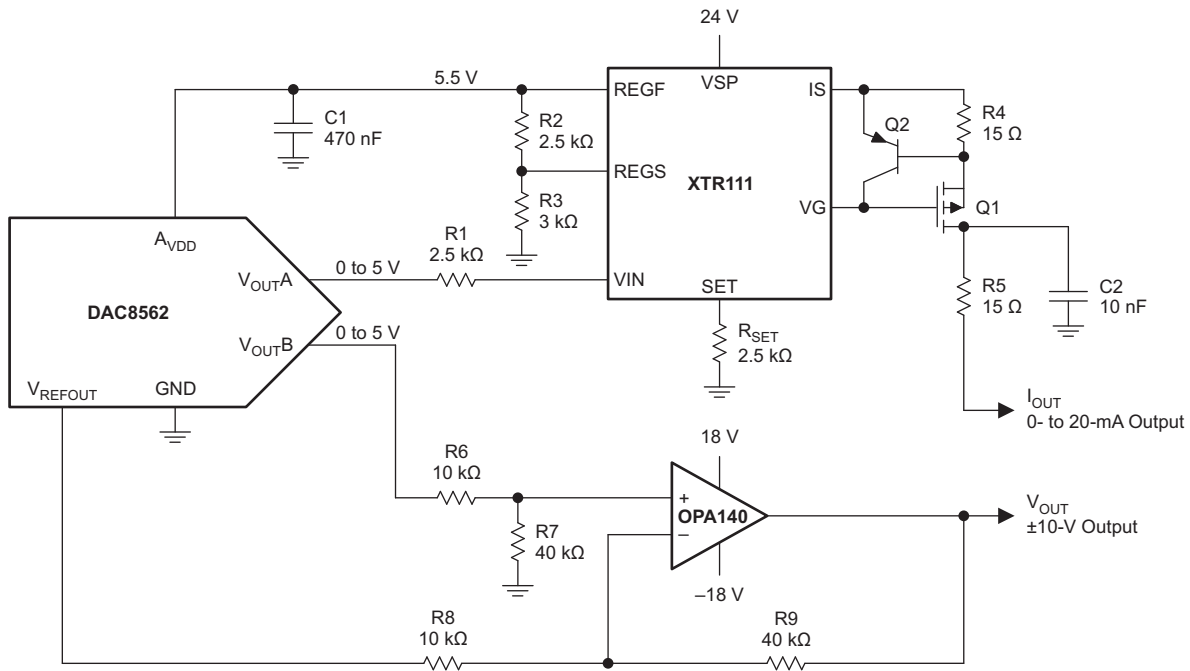

Figure 96. 0- to 20-mA and  $\pm 10$ -V Outputs Using DAC8562



## MICROPROCESSOR INTERFACING

### DAC756x/DAC816x/DAC856x to an MSP430 USI Interface

Figure 97 shows a serial interface between the DAC756x, DAC816x, or DAC856x and a typical MSP430 USI port such as the one found on the MSP430F2013. The port is configured in SPI master mode by setting bits 3, 5, 6, and 7 in USICTL0. The USI counter interrupt is set in USICTL1 to provide an efficient means of SPI communication with minimal software overhead. The serial clock polarity, source, and speed are controlled by settings in the USI clock control register (USICKCTL). The SYNC signal is derived from a bit-programmable pin on port 1; in this case, port line P1.4 is used. When data are to be transmitted to the DAC756x, DAC816x, or DAC856x, P1.4 is taken low. The USI transmits data in 8-bit bytes; thus, only eight falling clock edges occur in the transmit cycle. To load data to the DAC, P1.4 is left low after the first eight bits are transmitted; then, a second write cycle is initiated to transmit the second byte of data. P1.4 is taken high following the completion of the third write cycle.

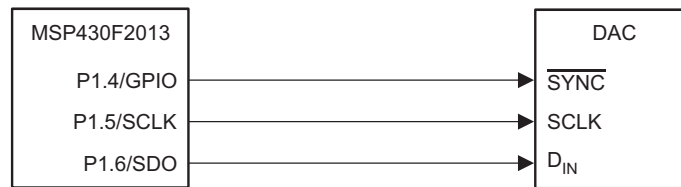

NOTE: Additional pins omitted for clarity.

Figure 97. DAC756x/DAC816x/DAC856x to MSP430 Interface

### DAC756x/DAC816x/DAC856x to a TMS320 McBSP Interface

Figure 98 shows an interface between the DAC756x, DAC816x, or DAC856x and any TMS320 series DSP from Texas Instruments with a multi-channel buffered serial port (McBSP). Serial data are shifted out on the rising edge of the serial clock and are clocked into the DAC756x, DAC816x, or DAC856x on the falling edge of the SCLK signal.

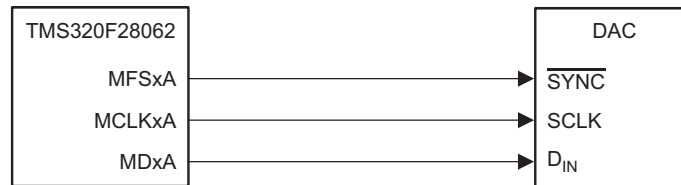

NOTE: Additional pins omitted for clarity.

Figure 98. DAC756x/DAC816x/DAC856x to TMS320 McBSP Interface

### DAC756x/DAC816x/DAC856x to an OMAP-L1x Processor

Figure 99 shows a serial interface between the DAC756x/DAC816x/DAC856x and the OMAP-L138. The transmit clock CLKx0 of the L138 drives SCLK of the DAC756x, DAC816x, or DAC856x, and the data transmit (Dx0) output drives the serial data line of the DAC. The SYNC signal is derived from the frame sync transmit (FSx0) line, similar to the TMS320 interface.

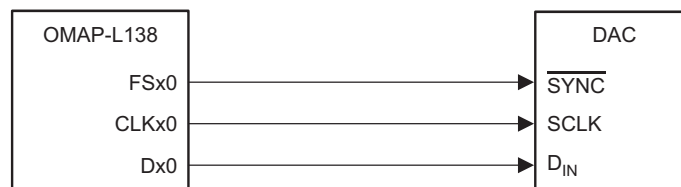

NOTE: Additional pins omitted for clarity.

Figure 99. DAC756x/DAC816x/DAC856x to OMAP-L1x Processor

## LAYOUT

A precision analog component requires careful layout, adequate bypassing, and clean, well-regulated power supplies. The DAC756x, DAC816x, and DAC856x offer single-supply operation, and are often used in close proximity with digital logic, microcontrollers, microprocessors, and digital signal processors. The more digital logic present in the design and the higher the switching speed, the more difficult it is to keep digital noise from appearing at the output. As a result of the single ground pin of the DAC756x, DAC816x, and DAC856x, all return currents (including digital and analog return currents for the DAC) must flow through a single point. Ideally, GND would be connected directly to an analog ground plane. This plane would be separate from the ground connection for the digital components until they were connected at the power-entry point of the system. The power applied to  $AV_{DD}$  should be well-regulated and low noise. Switching power supplies and dc/dc converters often have high-frequency glitches or spikes riding on the output voltage. In addition, digital components can create similar high-frequency spikes as their internal logic switches states. This noise can easily couple into the DAC output voltage through various paths between the power connections and analog output. As with the GND connection,  $AV_{DD}$  should be connected to a power-supply plane or trace that is separate from the connection for digital logic until they are connected at the power-entry point. In addition, a 1- $\mu$ F to 10- $\mu$ F capacitor and 0.1- $\mu$ F bypass capacitor are strongly recommended. In some situations, additional bypassing may be required, such as a 100- $\mu$ F electrolytic capacitor or even a pi filter made up of inductors and capacitors – all designed to essentially low-pass filter the supply and remove the high-frequency noise.

## PARAMETER DEFINITIONS

With the increased complexity of many different specifications listed in product data sheets, this section summarizes selected specifications related to digital-to-analog converters.

### STATIC PERFORMANCE

Static performance parameters are specifications such as differential nonlinearity (DNL) or integral nonlinearity (INL). These are dc specifications and provide information on the accuracy of the DAC. They are most important in applications where the signal changes slowly and accuracy is required.

#### Differential Nonlinearity (DNL)

Differential nonlinearity (DNL) is defined as the maximum deviation of the real LSB step from the ideal 1 LSB step. Ideally, any two adjacent digital codes correspond to output analog voltages that are exactly one LSB apart. If the DNL is less than 1 LSB, the DAC is said to be monotonic.

#### Full-Scale Error

Full-scale error is defined as the deviation of the real full-scale output voltage from the ideal output voltage while the DAC register is loaded with the full-scale code (0xFFFF). Ideally, the output should be  $V_{REF} - 1 \text{ LSB}$  or  $2 \times V_{REF} - 1 \text{ LSB}$ , depending on the DAC voltage gain. The full-scale error is expressed in percent of full-scale range (% FSR).

#### Full-Scale Error Drift

Full-scale error drift is defined as the change in full-scale error with a change in temperature. Full-scale error drift is expressed in units of ppm of FSR/°C.

#### Full-Scale Range (FSR)

Full-scale range (FSR) is the difference between the maximum and minimum analog output values that the DAC is specified to provide; typically, the maximum and minimum values are also specified. For an n-bit DAC, these values are usually given as the values matching with code 0 and  $2^n - 1$ .

#### Gain Error

Gain error is defined as the deviation in the slope of the real DAC transfer characteristic from the ideal transfer function. Gain error is expressed as a percentage of full-scale range (% FSR).

#### Gain Temperature Coefficient

The gain temperature coefficient is defined as the change in gain error with changes in temperature. The gain temperature coefficient is expressed in ppm of FSR/°C.

#### Least-Significant Bit (LSB)

The least significant bit (LSB) is defined as the smallest value in a binary coded system. The value of the LSB can be calculated by dividing the full-scale output voltage by  $2^n$ , where n is the resolution of the converter.

#### Monotonicity

Monotonicity is defined as a slope whose sign does not change. If a DAC is monotonic, the output changes in the same direction or remains constant for each step increase (or decrease) in the input code.

#### Most-Significant Bit (MSB)

The most significant bit (MSB) is defined as the largest value in a binary coded system. The value of the MSB can be calculated by dividing the full-scale output voltage by 2. Its value is one-half of full-scale.

#### Offset Error

The offset error is defined as the difference between actual output voltage and the ideal output voltage in the linear region of the transfer function. This difference is calculated by using a straight line defined by two codes (code 512 and code 65,024). Because the offset error is defined by a straight line, it can have a negative or positive value. Offset error is measured in mV.

#### Offset Error Drift

Offset error drift is defined as the change in offset error with a change in temperature. Offset error drift is expressed in  $\mu\text{V}/^\circ\text{C}$ .

#### Power-Supply Rejection Ratio (PSRR)

Power-supply rejection ratio (PSRR) is defined as the ratio of change in output voltage to a change in supply voltage for a full-scale output of the DAC. The PSRR of a device indicates how the output of the DAC is affected by changes in the supply voltage. PSRR is measured in decibels (dB).

### **Relative Accuracy or Integral Nonlinearity (INL)**

Relative accuracy or integral nonlinearity (INL) is defined as the maximum deviation between the real transfer function and a straight line passing through the endpoints of the ideal DAC transfer function. INL is measured in LSBs.

### **Resolution**

Generally, the DAC resolution can be expressed in different forms. Specifications such as IEC 60748-4 recognize the numerical, analog, and relative resolution. The numerical resolution is defined as the number of digits in the chosen numbering system necessary to express the total number of steps of the transfer characteristic, where a step represents both a digital input code and the corresponding discrete analogue output value. The most commonly-used definition of resolution provided in data sheets is the numerical resolution expressed in bits.

### **Zero-Code Error**

The zero-code error is defined as the DAC output voltage, when all 0s are loaded into the DAC register. Zero-code error is a measure of the difference between actual output voltage and ideal output voltage (0 V). It is expressed in mV. It is primarily caused by offsets in the output amplifier.

### **Zero-Code Error Drift**

Zero-code error drift is defined as the change in zero-code error with a change in temperature. Zero-code error drift is expressed in  $\mu\text{V}/^\circ\text{C}$ .

## DYNAMIC PERFORMANCE

Dynamic performance parameters are specifications such as settling time or slew rate, which are important in applications where the signal rapidly changes and/or high frequency signals are present.

### Channel-to-Channel Crosstalk

Crosstalk in a multi-channel DAC is defined as a glitch coupled onto the output of a channel (victim) when the output of an adjacent channel (aggressor) has a full-scale transition. It is calculated as the total area under the measured glitch on the victim channel at mid-scale code. It is expressed in nV-s.

### Channel-to-Channel DC Crosstalk

Channel-to-channel dc crosstalk is defined as the dc change in the output level of one DAC channel in response to a change in the output of another DAC channel. It is measured with a full-scale output change on one DAC channel while monitoring another DAC channel at mid-scale. It is expressed in LSB.

### Code Change/Digital-to-Analog Glitch Impulse

Digital-to-analog glitch impulse is the impulse injected into the analog output when the input code in the DAC register changes state. It is normally specified as the area of the glitch in nanovolt-seconds (nV-s), and is measured when the digital input code is changed by 1 LSB at the major carry transition.

### DAC Output Noise

DAC output noise is defined as any voltage deviation of DAC output from the desired value (within a particular frequency band). It is measured with a DAC channel kept at mid-scale while filtering the output voltage within a band of 0.1 Hz to 10 Hz and measuring its amplitude peaks. It is expressed in terms of peak-to-peak voltage ( $V_{PP}$ ).

### DAC Output Noise Density

Output noise density is defined as internally-generated random noise. Random noise is characterized as a spectral density ( $nV/\sqrt{Hz}$ ). It is measured by setting the DAC to mid-scale and measuring noise at the output.

### Digital Feedthrough

Digital feedthrough is defined as the impulse seen at the output of the DAC from the digital inputs of the DAC. It is measured when the DAC output is not updated. It is specified in nV-s, and measured with a full-scale code change on the data bus; that is, from all 0s to all 1s and vice versa.

### Output Voltage Settling Time

Settling time is the total time (including slew time) for the DAC output to settle within an error band around its final value after a change in input. Settling times are specified to within  $\pm 0.024\%$  FSR (or whatever value is stated) of full-scale range.

### Slew Rate

The output slew rate (SR) of an amplifier or other electronic circuit is defined as the maximum rate of change of the output voltage for all possible input signals.

$$SR = \max \left( \left| \frac{\Delta V_{OUT}(t)}{\Delta t} \right| \right) \quad (7)$$

Where  $\Delta V_{OUT}(t)$  is the output produced by the amplifier as a function of time t.

**PACKAGING INFORMATION**

| Orderable Device | Status <sup>(1)</sup> | Package Type | Package Drawing | Pins | Package Qty | Eco Plan <sup>(2)</sup>    | Lead/<br>Ball Finish | MSL Peak Temp <sup>(3)</sup> | Samples<br>(Requires Login) |
|------------------|-----------------------|--------------|-----------------|------|-------------|----------------------------|----------------------|------------------------------|-----------------------------|
| DAC7562SDGSR     | ACTIVE                | MSOP         | DGS             | 10   | 2500        | Green (RoHS<br>& no Sb/Br) | CU NIPDAU            | Level-2-260C-1 YEAR          |                             |
| DAC7562SDGST     | ACTIVE                | MSOP         | DGS             | 10   | 250         | TBD                        | Call TI              | Call TI                      |                             |
| DAC7562SDSCR     | ACTIVE                | SON          | DSC             | 10   | 3000        | Green (RoHS<br>& no Sb/Br) | CU NIPDAU            | Level-2-260C-1 YEAR          |                             |
| DAC7562SDSCT     | ACTIVE                | SON          | DSC             | 10   | 250         | Green (RoHS<br>& no Sb/Br) | CU NIPDAU            | Level-2-260C-1 YEAR          |                             |
| DAC7563SDGSR     | ACTIVE                | MSOP         | DGS             | 10   | 2500        | Green (RoHS<br>& no Sb/Br) | CU NIPDAU            | Level-2-260C-1 YEAR          |                             |
| DAC7563SDGST     | ACTIVE                | MSOP         | DGS             | 10   | 250         | Green (RoHS<br>& no Sb/Br) | CU NIPDAU            | Level-2-260C-1 YEAR          |                             |
| DAC7563SDSCR     | ACTIVE                | SON          | DSC             | 10   | 3000        | Green (RoHS<br>& no Sb/Br) | CU NIPDAU            | Level-2-260C-1 YEAR          |                             |
| DAC7563SDSCT     | ACTIVE                | SON          | DSC             | 10   | 250         | Green (RoHS<br>& no Sb/Br) | CU NIPDAU            | Level-2-260C-1 YEAR          |                             |
| DAC8162SDGSR     | ACTIVE                | MSOP         | DGS             | 10   | 2500        | Green (RoHS<br>& no Sb/Br) | CU NIPDAU            | Level-2-260C-1 YEAR          |                             |
| DAC8162SDGST     | ACTIVE                | MSOP         | DGS             | 10   | 250         | Green (RoHS<br>& no Sb/Br) | CU NIPDAU            | Level-2-260C-1 YEAR          |                             |
| DAC8162SDSCR     | ACTIVE                | SON          | DSC             | 10   | 3000        | Green (RoHS<br>& no Sb/Br) | CU NIPDAU            | Level-2-260C-1 YEAR          |                             |
| DAC8162SDSCT     | ACTIVE                | SON          | DSC             | 10   | 250         | Green (RoHS<br>& no Sb/Br) | CU NIPDAU            | Level-2-260C-1 YEAR          |                             |
| DAC8163SDGSR     | ACTIVE                | MSOP         | DGS             | 10   | 2500        | Green (RoHS<br>& no Sb/Br) | CU NIPDAU            | Level-2-260C-1 YEAR          |                             |
| DAC8163SDGST     | ACTIVE                | MSOP         | DGS             | 10   | 250         | Green (RoHS<br>& no Sb/Br) | CU NIPDAU            | Level-2-260C-1 YEAR          |                             |
| DAC8163SDSCR     | ACTIVE                | SON          | DSC             | 10   | 3000        | Green (RoHS<br>& no Sb/Br) | CU NIPDAU            | Level-2-260C-1 YEAR          |                             |
| DAC8163SDSCT     | ACTIVE                | SON          | DSC             | 10   | 250         | Green (RoHS<br>& no Sb/Br) | CU NIPDAU            | Level-2-260C-1 YEAR          |                             |
| DAC8562SDGSR     | ACTIVE                | MSOP         | DGS             | 10   | 2500        | Green (RoHS<br>& no Sb/Br) | CU NIPDAU            | Level-2-260C-1 YEAR          |                             |

| Orderable Device | Status <sup>(1)</sup> | Package Type | Package Drawing | Pins | Package Qty | Eco Plan <sup>(2)</sup> | Lead/<br>Ball Finish | MSL Peak Temp <sup>(3)</sup> | Samples<br>(Requires Login) |
|------------------|-----------------------|--------------|-----------------|------|-------------|-------------------------|----------------------|------------------------------|-----------------------------|
| DAC8562SDGST     | ACTIVE                | MSOP         | DGS             | 10   | 250         | Green (RoHS & no Sb/Br) | CU NIPDAU            | Level-2-260C-1 YEAR          |                             |
| DAC8562SDSCR     | ACTIVE                | SON          | DSC             | 10   | 3000        | Green (RoHS & no Sb/Br) | CU NIPDAU            | Level-2-260C-1 YEAR          |                             |
| DAC8562SDSCT     | ACTIVE                | SON          | DSC             | 10   | 250         | Green (RoHS & no Sb/Br) | CU NIPDAU            | Level-2-260C-1 YEAR          |                             |
| DAC8563SDGSR     | ACTIVE                | MSOP         | DGS             | 10   | 2500        | Green (RoHS & no Sb/Br) | CU NIPDAU            | Level-2-260C-1 YEAR          |                             |
| DAC8563SDGST     | ACTIVE                | MSOP         | DGS             | 10   | 250         | Green (RoHS & no Sb/Br) | CU NIPDAU            | Level-2-260C-1 YEAR          |                             |
| DAC8563SDSCR     | ACTIVE                | SON          | DSC             | 10   | 3000        | Green (RoHS & no Sb/Br) | CU NIPDAU            | Level-2-260C-1 YEAR          |                             |
| DAC8563SDSCT     | ACTIVE                | SON          | DSC             | 10   | 250         | Green (RoHS & no Sb/Br) | CU NIPDAU            | Level-2-260C-1 YEAR          |                             |

<sup>(1)</sup> The marketing status values are defined as follows:

**ACTIVE:** Product device recommended for new designs.

**LIFEBUY:** TI has announced that the device will be discontinued, and a lifetime-buy period is in effect.

**NRND:** Not recommended for new designs. Device is in production to support existing customers, but TI does not recommend using this part in a new design.

**PREVIEW:** Device has been announced but is not in production. Samples may or may not be available.

**OBSOLETE:** TI has discontinued the production of the device.

<sup>(2)</sup> Eco Plan - The planned eco-friendly classification: Pb-Free (RoHS), Pb-Free (RoHS Exempt), or Green (RoHS & no Sb/Br) - please check <http://www.ti.com/productcontent> for the latest availability information and additional product content details.

**TBD:** The Pb-Free/Green conversion plan has not been defined.

**Pb-Free (RoHS):** TI's terms "Lead-Free" or "Pb-Free" mean semiconductor products that are compatible with the current RoHS requirements for all 6 substances, including the requirement that lead not exceed 0.1% by weight in homogeneous materials. Where designed to be soldered at high temperatures, TI Pb-Free products are suitable for use in specified lead-free processes.

**Pb-Free (RoHS Exempt):** This component has a RoHS exemption for either 1) lead-based flip-chip solder bumps used between the die and package, or 2) lead-based die adhesive used between the die and leadframe. The component is otherwise considered Pb-Free (RoHS compatible) as defined above.

**Green (RoHS & no Sb/Br):** TI defines "Green" to mean Pb-Free (RoHS compatible), and free of Bromine (Br) and Antimony (Sb) based flame retardants (Br or Sb do not exceed 0.1% by weight in homogeneous material)

<sup>(3)</sup> MSL, Peak Temp. -- The Moisture Sensitivity Level rating according to the JEDEC industry standard classifications, and peak solder temperature.

**Important Information and Disclaimer:** The information provided on this page represents TI's knowledge and belief as of the date that it is provided. TI bases its knowledge and belief on information provided by third parties, and makes no representation or warranty as to the accuracy of such information. Efforts are underway to better integrate information from third parties. TI has taken and continues to take reasonable steps to provide representative and accurate information but may not have conducted destructive testing or chemical analysis on incoming materials and chemicals. TI and TI suppliers consider certain information to be proprietary, and thus CAS numbers and other limited information may not be available for release.

In no event shall TI's liability arising out of such information exceed the total purchase price of the TI part(s) at issue in this document sold by TI to Customer on an annual basis.



**TAPE AND REEL INFORMATION**

**QUADRANT ASSIGNMENTS FOR PIN 1 ORIENTATION IN TAPE**

\*All dimensions are nominal

| Device       | Package Type | Package Drawing | Pins | SPQ  | Reel Diameter (mm) | Reel Width W1 (mm) | A0 (mm) | B0 (mm) | K0 (mm) | P1 (mm) | W (mm) | Pin1 Quadrant |
|--------------|--------------|-----------------|------|------|--------------------|--------------------|---------|---------|---------|---------|--------|---------------|
| DAC7562SDGSR | MSOP         | DGS             | 10   | 2500 | 330.0              | 12.4               | 5.3     | 3.3     | 1.3     | 8.0     | 12.0   | Q1            |
| DAC7562SDSCR | SON          | DSC             | 10   | 3000 | 330.0              | 12.4               | 3.3     | 3.3     | 1.1     | 8.0     | 12.0   | Q2            |
| DAC7562SDSCT | SON          | DSC             | 10   | 250  | 180.0              | 12.4               | 3.3     | 3.3     | 1.1     | 8.0     | 12.0   | Q2            |
| DAC7563SDGSR | MSOP         | DGS             | 10   | 2500 | 330.0              | 12.4               | 5.3     | 3.3     | 1.3     | 8.0     | 12.0   | Q1            |
| DAC7563SDGST | MSOP         | DGS             | 10   | 250  | 180.0              | 12.4               | 5.3     | 3.3     | 1.3     | 8.0     | 12.0   | Q1            |
| DAC7563SDSCR | SON          | DSC             | 10   | 3000 | 330.0              | 12.4               | 3.3     | 3.3     | 1.1     | 8.0     | 12.0   | Q2            |
| DAC7563SDSCT | SON          | DSC             | 10   | 250  | 180.0              | 12.4               | 3.3     | 3.3     | 1.1     | 8.0     | 12.0   | Q2            |
| DAC8162SDGSR | MSOP         | DGS             | 10   | 2500 | 330.0              | 12.4               | 5.3     | 3.3     | 1.3     | 8.0     | 12.0   | Q1            |
| DAC8162SDGST | MSOP         | DGS             | 10   | 250  | 180.0              | 12.4               | 5.3     | 3.3     | 1.3     | 8.0     | 12.0   | Q1            |
| DAC8162SDSCR | SON          | DSC             | 10   | 3000 | 330.0              | 12.4               | 3.3     | 3.3     | 1.1     | 8.0     | 12.0   | Q2            |
| DAC8162SDSCT | SON          | DSC             | 10   | 250  | 180.0              | 12.4               | 3.3     | 3.3     | 1.1     | 8.0     | 12.0   | Q2            |
| DAC8163SDGSR | MSOP         | DGS             | 10   | 2500 | 330.0              | 12.4               | 5.3     | 3.3     | 1.3     | 8.0     | 12.0   | Q1            |
| DAC8163SDGST | MSOP         | DGS             | 10   | 250  | 180.0              | 12.4               | 5.3     | 3.3     | 1.3     | 8.0     | 12.0   | Q1            |
| DAC8163SDSCR | SON          | DSC             | 10   | 3000 | 330.0              | 12.4               | 3.3     | 3.3     | 1.1     | 8.0     | 12.0   | Q2            |
| DAC8163SDSCT | SON          | DSC             | 10   | 250  | 180.0              | 12.4               | 3.3     | 3.3     | 1.1     | 8.0     | 12.0   | Q2            |
| DAC8562SDGSR | MSOP         | DGS             | 10   | 2500 | 330.0              | 12.4               | 5.3     | 3.3     | 1.3     | 8.0     | 12.0   | Q1            |
| DAC8562SDGST | MSOP         | DGS             | 10   | 250  | 180.0              | 12.4               | 5.3     | 3.3     | 1.3     | 8.0     | 12.0   | Q1            |
| DAC8562SDSCR | SON          | DSC             | 10   | 3000 | 330.0              | 12.4               | 3.3     | 3.3     | 1.1     | 8.0     | 12.0   | Q2            |

| Device       | Package Type | Package Drawing | Pins | SPQ  | Reel Diameter (mm) | Reel Width W1 (mm) | A0 (mm) | B0 (mm) | K0 (mm) | P1 (mm) | W (mm) | Pin1 Quadrant |
|--------------|--------------|-----------------|------|------|--------------------|--------------------|---------|---------|---------|---------|--------|---------------|
| DAC8562SDSCT | SON          | DSC             | 10   | 250  | 180.0              | 12.4               | 3.3     | 3.3     | 1.1     | 8.0     | 12.0   | Q2            |
| DAC8563SDGSR | MSOP         | DGS             | 10   | 2500 | 330.0              | 12.4               | 5.3     | 3.3     | 1.3     | 8.0     | 12.0   | Q1            |
| DAC8563SDGST | MSOP         | DGS             | 10   | 250  | 180.0              | 12.4               | 5.3     | 3.3     | 1.3     | 8.0     | 12.0   | Q1            |
| DAC8563SDSCR | SON          | DSC             | 10   | 3000 | 330.0              | 12.4               | 3.3     | 3.3     | 1.1     | 8.0     | 12.0   | Q2            |
| DAC8563SDSCT | SON          | DSC             | 10   | 250  | 180.0              | 12.4               | 3.3     | 3.3     | 1.1     | 8.0     | 12.0   | Q2            |

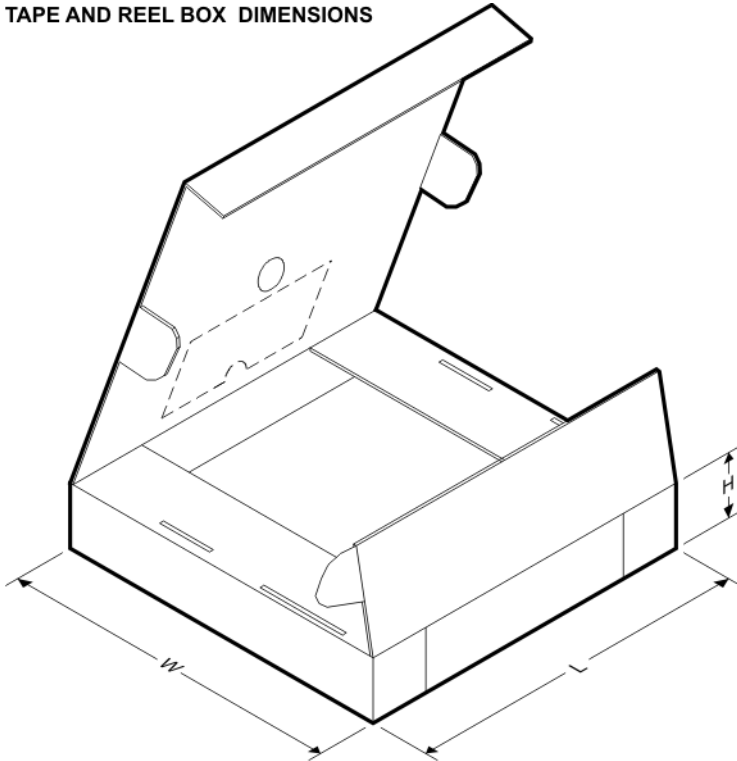
**TAPE AND REEL BOX DIMENSIONS**

\*All dimensions are nominal

| Device       | Package Type | Package Drawing | Pins | SPQ  | Length (mm) | Width (mm) | Height (mm) |
|--------------|--------------|-----------------|------|------|-------------|------------|-------------|
| DAC7562SDGSR | MSOP         | DGS             | 10   | 2500 | 370.0       | 355.0      | 55.0        |
| DAC7562SDSCR | SON          | DSC             | 10   | 3000 | 346.0       | 346.0      | 29.0        |
| DAC7562SDSCT | SON          | DSC             | 10   | 250  | 190.5       | 212.7      | 31.8        |
| DAC7563SDGSR | MSOP         | DGS             | 10   | 2500 | 370.0       | 355.0      | 55.0        |
| DAC7563SDGST | MSOP         | DGS             | 10   | 250  | 220.0       | 205.0      | 50.0        |
| DAC7563SDSCR | SON          | DSC             | 10   | 3000 | 346.0       | 346.0      | 29.0        |
| DAC7563SDSCT | SON          | DSC             | 10   | 250  | 190.5       | 212.7      | 31.8        |
| DAC8162SDGSR | MSOP         | DGS             | 10   | 2500 | 370.0       | 355.0      | 55.0        |
| DAC8162SDGST | MSOP         | DGS             | 10   | 250  | 220.0       | 205.0      | 50.0        |
| DAC8162SDSCR | SON          | DSC             | 10   | 3000 | 346.0       | 346.0      | 29.0        |
| DAC8162SDSCT | SON          | DSC             | 10   | 250  | 190.5       | 212.7      | 31.8        |
| DAC8163SDGSR | MSOP         | DGS             | 10   | 2500 | 370.0       | 355.0      | 55.0        |

| Device       | Package Type | Package Drawing | Pins | SPQ  | Length (mm) | Width (mm) | Height (mm) |
|--------------|--------------|-----------------|------|------|-------------|------------|-------------|
| DAC8163SDGST | MSOP         | DGS             | 10   | 250  | 220.0       | 205.0      | 50.0        |
| DAC8163SDSCR | SON          | DSC             | 10   | 3000 | 346.0       | 346.0      | 29.0        |
| DAC8163SDSCT | SON          | DSC             | 10   | 250  | 190.5       | 212.7      | 31.8        |
| DAC8562SDGSR | MSOP         | DGS             | 10   | 2500 | 370.0       | 355.0      | 55.0        |
| DAC8562SDGST | MSOP         | DGS             | 10   | 250  | 220.0       | 205.0      | 50.0        |
| DAC8562SDSCR | SON          | DSC             | 10   | 3000 | 346.0       | 346.0      | 29.0        |
| DAC8562SDSCT | SON          | DSC             | 10   | 250  | 190.5       | 212.7      | 31.8        |
| DAC8563SDGSR | MSOP         | DGS             | 10   | 2500 | 370.0       | 355.0      | 55.0        |
| DAC8563SDGST | MSOP         | DGS             | 10   | 250  | 220.0       | 205.0      | 50.0        |
| DAC8563SDSCR | SON          | DSC             | 10   | 3000 | 346.0       | 346.0      | 29.0        |
| DAC8563SDSCT | SON          | DSC             | 10   | 250  | 190.5       | 212.7      | 31.8        |

DGS (S-PDSO-G10)

PLASTIC SMALL-OUTLINE PACKAGE

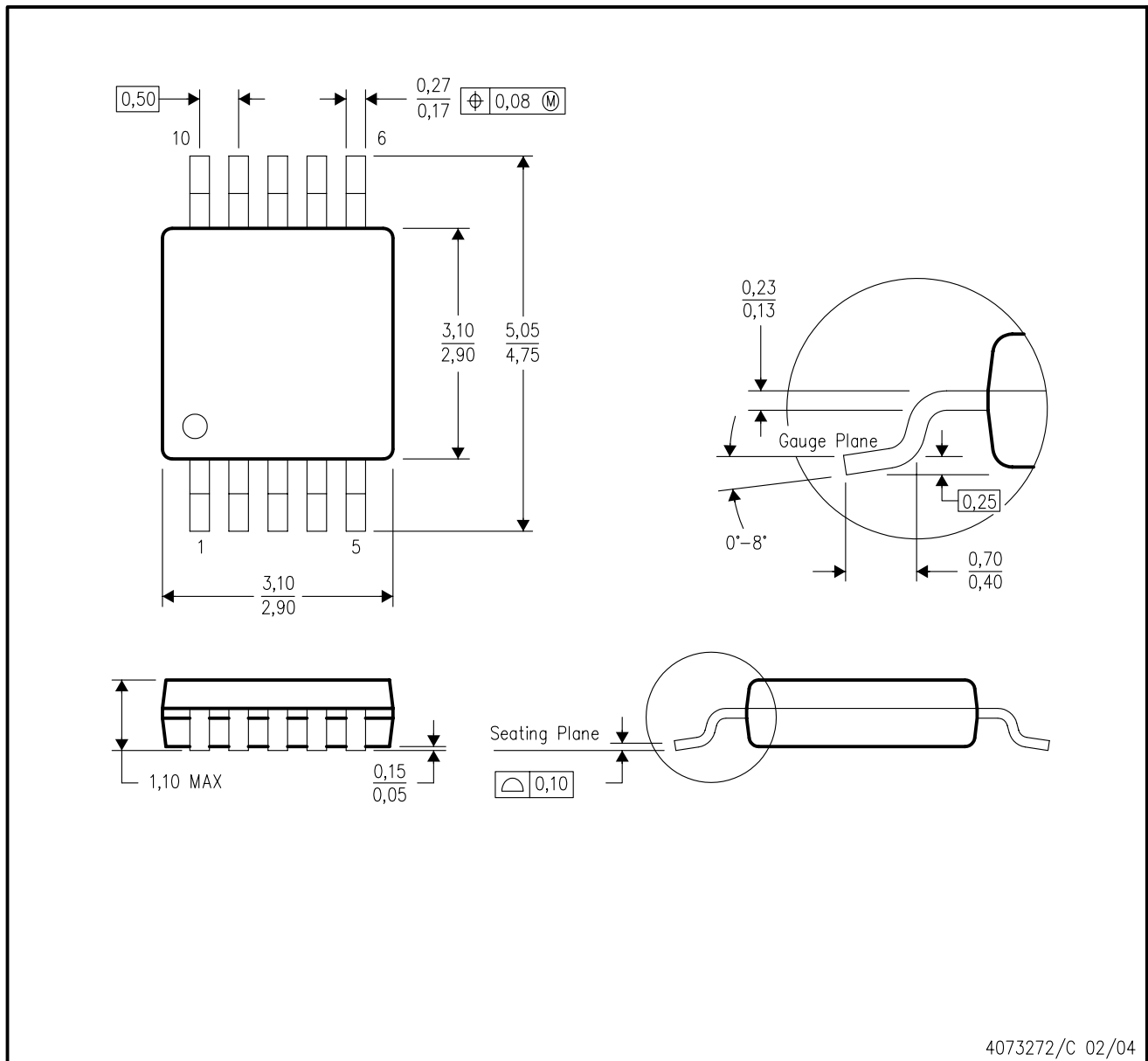

4073272/C 02/04

- NOTES:
- A. All linear dimensions are in millimeters.
  - B. This drawing is subject to change without notice.
  - C. Body dimensions do not include mold flash or protrusion.
  - D. Falls within JEDEC MO-187 variation BA.

DSC (S-PWSON-N10)

PLASTIC SMALL OUTLINE NO-LEAD

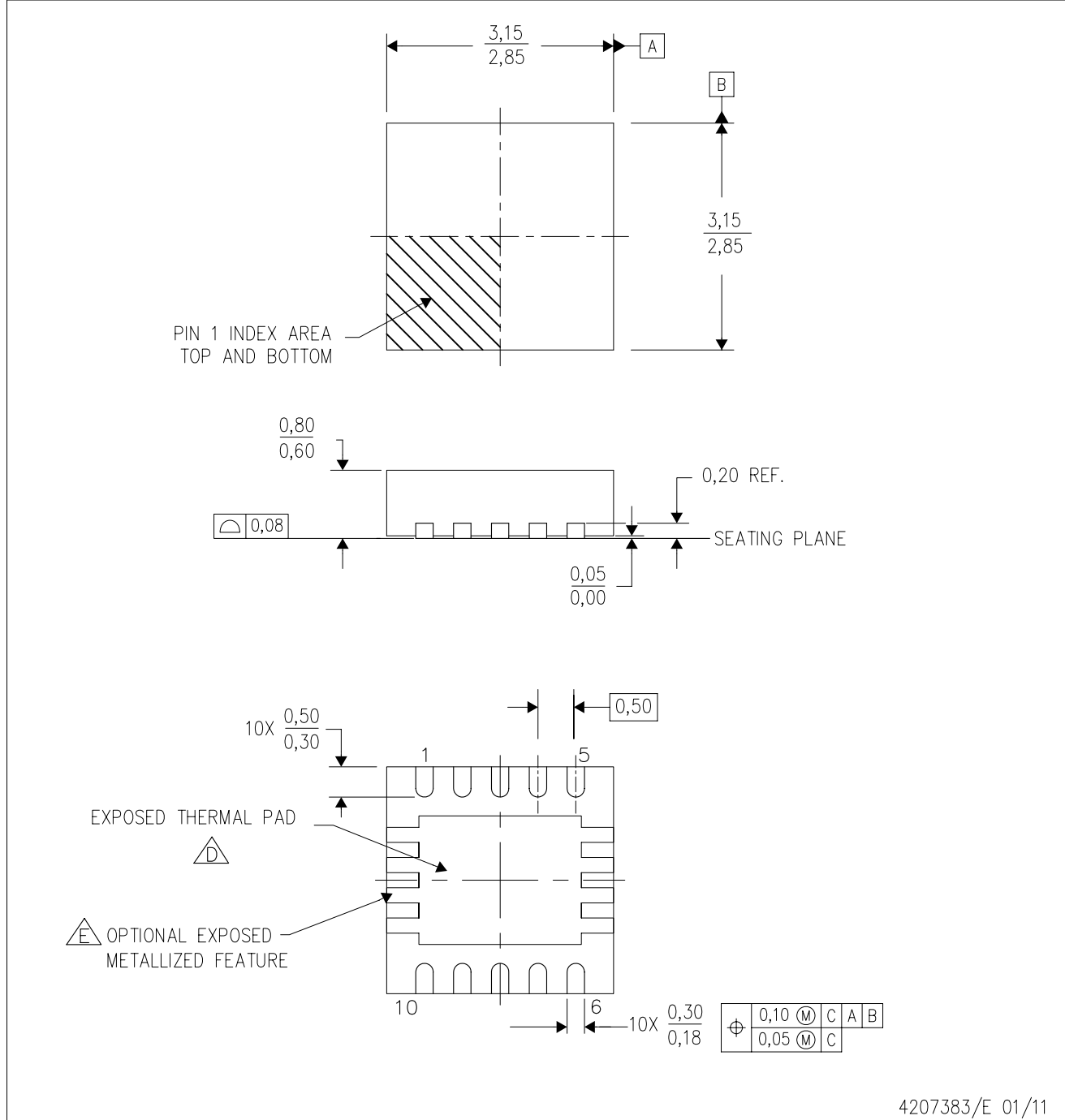

- NOTES:
- A. All linear dimensions are in millimeters. Dimensioning and tolerancing per ASME Y14.5M-1994.
  - B. This drawing is subject to change without notice.
  - C. Small Outline No-Lead (SON) package configuration.
  - D. The package thermal pad must be soldered to the board for thermal and mechanical performance.
  - E. See the Product Data Sheet for details regarding the exposed thermal pad features and dimensions.

# THERMAL PAD MECHANICAL DATA

DSC (S-PWSON-N10)

PLASTIC SMALL OUTLINE NO-LEAD

## THERMAL INFORMATION

This package incorporates an exposed thermal pad that is designed to be attached directly to an external heatsink. The thermal pad must be soldered directly to the printed circuit board (PCB). After soldering, the PCB can be used as a heatsink. In addition, through the use of thermal vias, the thermal pad can be attached directly to the appropriate copper plane shown in the electrical schematic for the device, or alternatively, can be attached to a special heatsink structure designed into the PCB. This design optimizes the heat transfer from the integrated circuit (IC).

For information on the Quad Flatpack No-Lead (QFN) package and its advantages, refer to Application Report, QFN/SON PCB Attachment, Texas Instruments Literature No. SLUA271. This document is available at [www.ti.com](http://www.ti.com).

The exposed thermal pad dimensions for this package are shown in the following illustration.

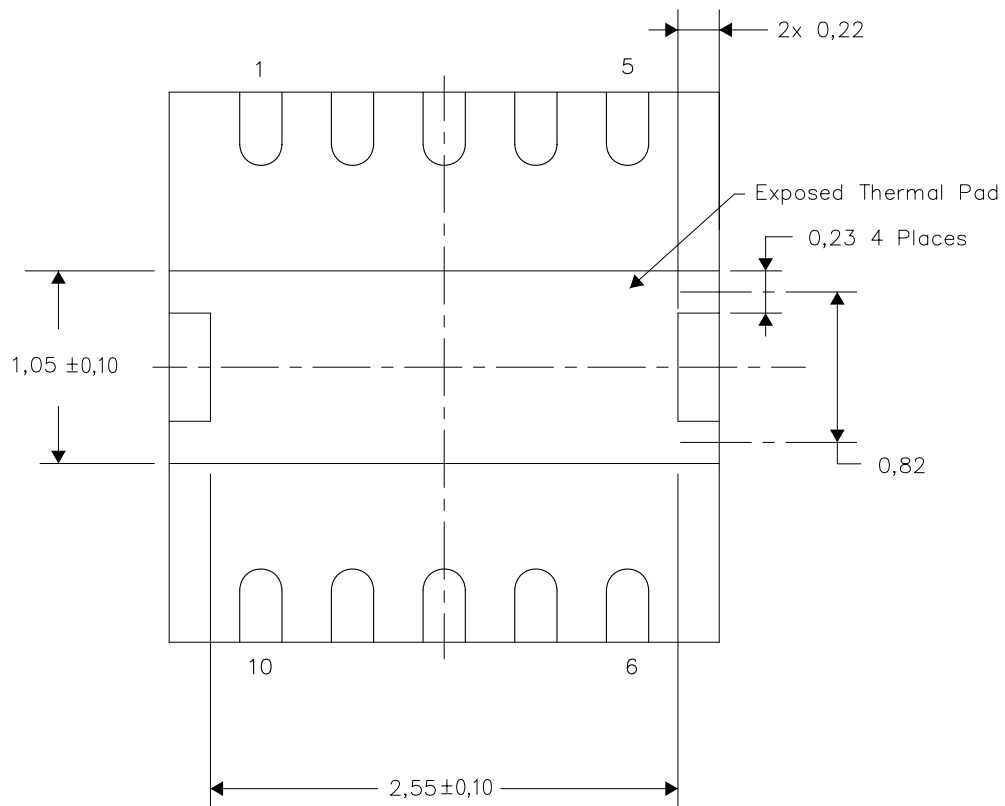

Bottom View

Exposed Thermal Pad Dimensions

4210391-4/F 04/11

NOTE: A. All linear dimensions are in millimeters

DSC (S-PWSON-N10)

PLASTIC SMALL OUTLINE NO-LEAD

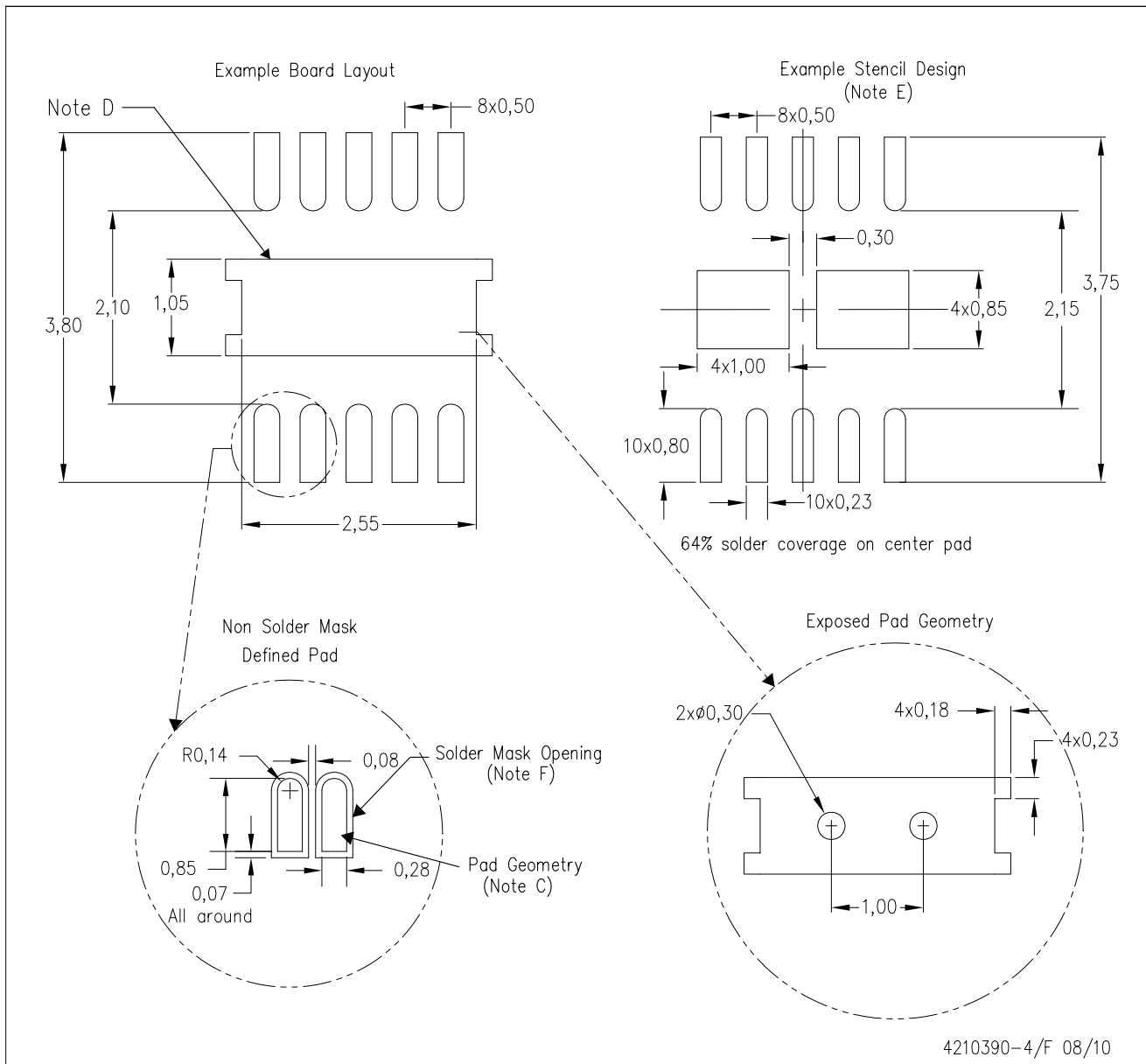

- NOTES:
- All linear dimensions are in millimeters.
  - This drawing is subject to change without notice.
  - Publication IPC-7351 is recommended for alternate designs.
  - This package is designed to be soldered to a thermal pad on the board. Refer to Application Note, Quad Flat-Pack Packages, Texas Instruments Literature No. SLUA271, and also the Product Data Sheets for specific thermal information, via requirements, and recommended board layout. These documents are available at [www.ti.com](http://www.ti.com) <<http://www.ti.com>>.
  - Laser cutting apertures with trapezoidal walls and also rounding corners will offer better paste release. Customers should contact their board assembly site for stencil design recommendations. Refer to IPC 7525 for stencil design considerations.
  - Customers should contact their board fabrication site for minimum solder mask web tolerances between signal pads.

## IMPORTANT NOTICE

Texas Instruments Incorporated and its subsidiaries (TI) reserve the right to make corrections, modifications, enhancements, improvements, and other changes to its products and services at any time and to discontinue any product or service without notice. Customers should obtain the latest relevant information before placing orders and should verify that such information is current and complete. All products are sold subject to TI's terms and conditions of sale supplied at the time of order acknowledgment.

TI warrants performance of its hardware products to the specifications applicable at the time of sale in accordance with TI's standard warranty. Testing and other quality control techniques are used to the extent TI deems necessary to support this warranty. Except where mandated by government requirements, testing of all parameters of each product is not necessarily performed.

TI assumes no liability for applications assistance or customer product design. Customers are responsible for their products and applications using TI components. To minimize the risks associated with customer products and applications, customers should provide adequate design and operating safeguards.

TI does not warrant or represent that any license, either express or implied, is granted under any TI patent right, copyright, mask work right, or other TI intellectual property right relating to any combination, machine, or process in which TI products or services are used. Information published by TI regarding third-party products or services does not constitute a license from TI to use such products or services or a warranty or endorsement thereof. Use of such information may require a license from a third party under the patents or other intellectual property of the third party, or a license from TI under the patents or other intellectual property of TI.

Reproduction of TI information in TI data books or data sheets is permissible only if reproduction is without alteration and is accompanied by all associated warranties, conditions, limitations, and notices. Reproduction of this information with alteration is an unfair and deceptive business practice. TI is not responsible or liable for such altered documentation. Information of third parties may be subject to additional restrictions.

Resale of TI products or services with statements different from or beyond the parameters stated by TI for that product or service voids all express and any implied warranties for the associated TI product or service and is an unfair and deceptive business practice. TI is not responsible or liable for any such statements.

TI products are not authorized for use in safety-critical applications (such as life support) where a failure of the TI product would reasonably be expected to cause severe personal injury or death, unless officers of the parties have executed an agreement specifically governing such use. Buyers represent that they have all necessary expertise in the safety and regulatory ramifications of their applications, and acknowledge and agree that they are solely responsible for all legal, regulatory and safety-related requirements concerning their products and any use of TI products in such safety-critical applications, notwithstanding any applications-related information or support that may be provided by TI. Further, Buyers must fully indemnify TI and its representatives against any damages arising out of the use of TI products in such safety-critical applications.

TI products are neither designed nor intended for use in military/aerospace applications or environments unless the TI products are specifically designated by TI as military-grade or "enhanced plastic." Only products designated by TI as military-grade meet military specifications. Buyers acknowledge and agree that any such use of TI products which TI has not designated as military-grade is solely at the Buyer's risk, and that they are solely responsible for compliance with all legal and regulatory requirements in connection with such use.

TI products are neither designed nor intended for use in automotive applications or environments unless the specific TI products are designated by TI as compliant with ISO/TS 16949 requirements. Buyers acknowledge and agree that, if they use any non-designated products in automotive applications, TI will not be responsible for any failure to meet such requirements.

Following are URLs where you can obtain information on other Texas Instruments products and application solutions:

### Products

|                             |  |
|-----------------------------|--|
| Audio                       | <a href="http://www.ti.com/audio">www.ti.com/audio</a>             |
| Amplifiers                  | <a href="http://amplifier.ti.com">amplifier.ti.com</a>             |
| Data Converters             | <a href="http://dataconverter.ti.com">dataconverter.ti.com</a>     |
| DLP® Products               | <a href="http://www.dlp.com">www.dlp.com</a>                       |
| DSP                         | <a href="http://dsp.ti.com">dsp.ti.com</a>                         |
| Clocks and Timers           | <a href="http://www.ti.com/clocks">www.ti.com/clocks</a>           |
| Interface                   | <a href="http://interface.ti.com">interface.ti.com</a>             |
| Logic                       | <a href="http://logic.ti.com">logic.ti.com</a>                     |
| Power Mgmt                  | <a href="http://power.ti.com">power.ti.com</a>                     |
| Microcontrollers            | <a href="http://microcontroller.ti.com">microcontroller.ti.com</a> |
| RFID                        | <a href="http://www.ti-rfid.com">www.ti-rfid.com</a>               |
| RF/IF and ZigBee® Solutions | <a href="http://www.ti.com/lprf">www.ti.com/lprf</a>               |

### Applications

|                               |  |
|-------------------------------|--|
| Communications and Telecom    | <a href="http://www.ti.com/communications">www.ti.com/communications</a>                 |
| Computers and Peripherals     | <a href="http://www.ti.com/computers">www.ti.com/computers</a>                           |
| Consumer Electronics          | <a href="http://www.ti.com/consumer-apps">www.ti.com/consumer-apps</a>                   |
| Energy and Lighting           | <a href="http://www.ti.com/energy">www.ti.com/energy</a>                                 |
| Industrial                    | <a href="http://www.ti.com/industrial">www.ti.com/industrial</a>                         |
| Medical                       | <a href="http://www.ti.com/medical">www.ti.com/medical</a>                               |
| Security                      | <a href="http://www.ti.com/security">www.ti.com/security</a>                             |
| Space, Avionics and Defense   | <a href="http://www.ti.com/space-avionics-defense">www.ti.com/space-avionics-defense</a> |
| Transportation and Automotive | <a href="http://www.ti.com/automotive">www.ti.com/automotive</a>                         |
| Video and Imaging             | <a href="http://www.ti.com/video">www.ti.com/video</a>                                   |
| Wireless                      | <a href="http://www.ti.com/wireless-apps">www.ti.com/wireless-apps</a>                   |

TI E2E Community Home Page

[e2e.ti.com](http://e2e.ti.com)

Mailing Address: Texas Instruments, Post Office Box 655303, Dallas, Texas 75265  
Copyright © 2011, Texas Instruments Incorporated